

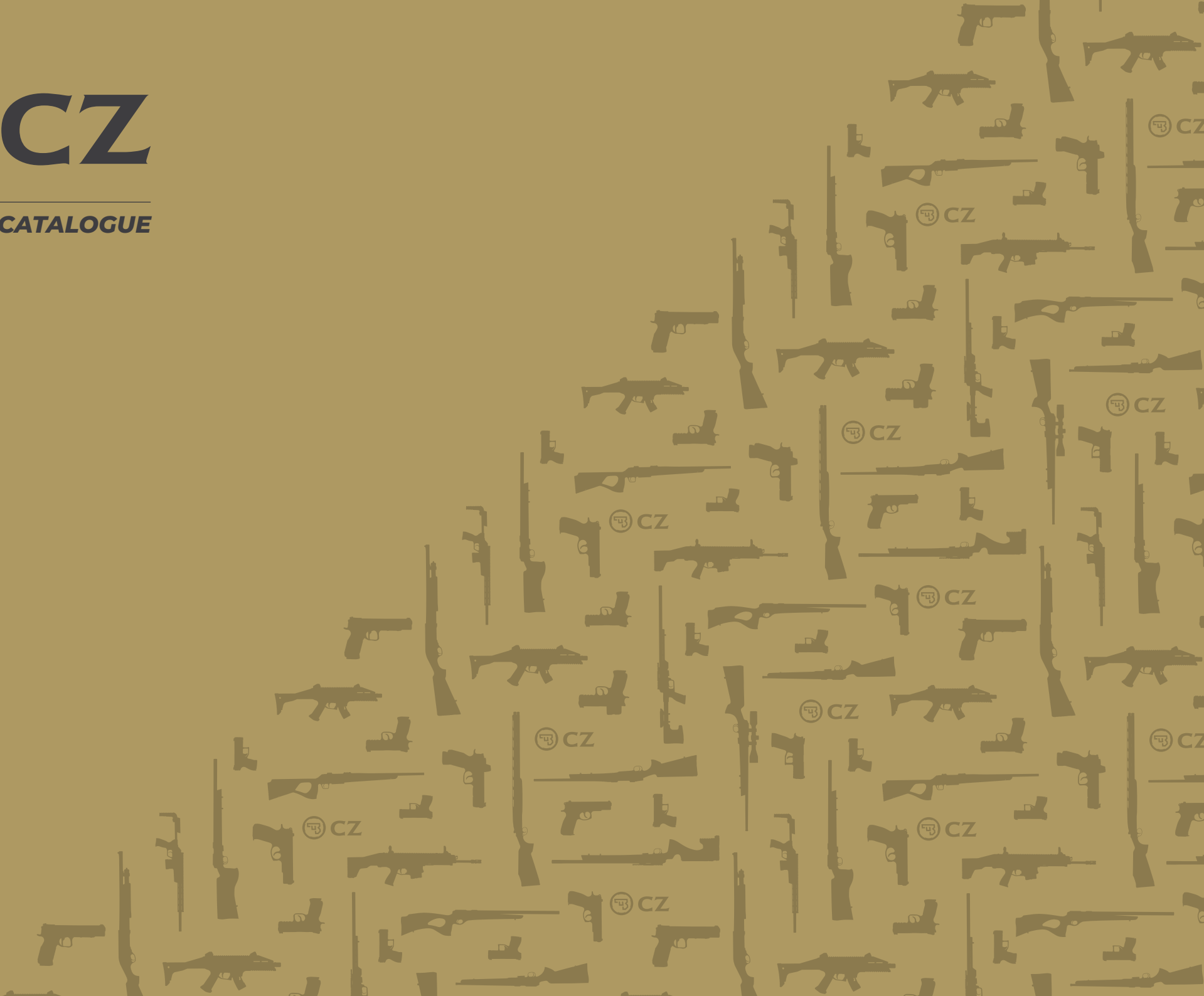

PRODUCT CATALOGUE



**WE DISTRIBUTE OUR PRODUCTS
TO MORE THAN 100 COUNTRIES
AROUND THE WORLD**



Scan to find
the nearest CZ dealer,
store or service center.

The technical specifications provided are for orientation purposes only and may vary according to the specific configuration. The manufacturer reserves the right to make changes or modifications at its sole discretion.

CONTENTS

PISTOLS	10
CZ SHADOW 2 SERIES	12
CZ TS 2 SERIES	28
CZ P-10 SERIES	36
CZ P-09 NOCTURNE	48
ADAPTERS KADET	56
CENTERFIRE RIFLES	60
CZ 600 SERIES	62
RIMFIRE RIFLES	90
CZ 457 SERIES	92
SHOTGUNS	118
CZ-USA FIELD SPORTS SERIES	120
SEMI-AUTOMATIC RIFLES / CARBINES	126
CZ SCORPION EVO 3 S1/S2 SERIES	128
CZ BREN 2 Ms SERIES	138
ACCESSORIES	144

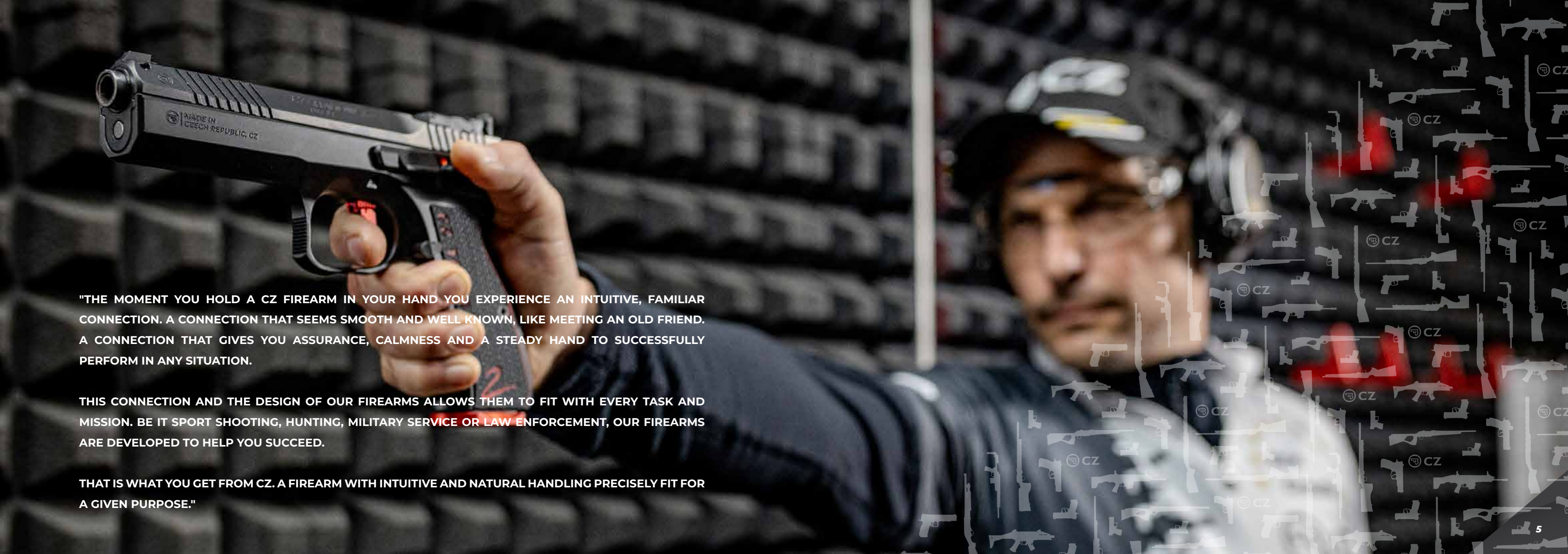

"THE MOMENT YOU HOLD A CZ FIREARM IN YOUR HAND YOU EXPERIENCE AN INTUITIVE, FAMILIAR CONNECTION. A CONNECTION THAT SEEMS SMOOTH AND WELL KNOWN, LIKE MEETING AN OLD FRIEND. A CONNECTION THAT GIVES YOU ASSURANCE, CALMNESS AND A STEADY HAND TO SUCCESSFULLY PERFORM IN ANY SITUATION.

THIS CONNECTION AND THE DESIGN OF OUR FIREARMS ALLOWS THEM TO FIT WITH EVERY TASK AND MISSION. BE IT SPORT SHOOTING, HUNTING, MILITARY SERVICE OR LAW ENFORCEMENT, OUR FIREARMS ARE DEVELOPED TO HELP YOU SUCCEED.

THAT IS WHAT YOU GET FROM CZ. A FIREARM WITH INTUITIVE AND NATURAL HANDLING PRECISELY FIT FOR A GIVEN PURPOSE."



Dear Customers, Business Partners, and Supporters of the CZ brand,

Welcome to our product catalogue - a world of innovation, precision design, and professional workmanship. **Ceska zbrojovka** is one of the main pillars of the international **Colt CZ Group**, the world's leading manufacturer of small arms, ammunition, ballistic protection, and other accessories. CZ branded products have been designed for the armed forces, self-defense, sport shooting, hunting, and other commercial applications.

The strength of the brand lies in the shared know-how, synergy, and values that enable us to offer users a top range of products that are characterized by high reliability, outstanding performance, and advanced ergonomics. We have developed a number of new, innovative products for the upcoming season that include the **CZ SHADOW 2 TARGET, CZ P-09 NOCTURNE, CZ 600 PLUS ERGO DRIVEN HUNT**, and others.

I wish you all the best in the choice of your new CZ firearm, and if you are a new customer, we are honored to welcome you to the ever-expanding group of CZ supporters!



Jan Zajic
CEO and Chairman of the Board of Directors
Ceska zbrojovka

LIFETIME BARREL WARRANTY



High precision, impressive durability, and a long service life. These are just a few of the many advantages that come with cold forged barrels. Cold hammer forging is a very complex and demanding process that is not easy to master. Many manufacturers are replacing it with simpler and cheaper methods, such as extrusion or broaching. However, the resulting product lacks some of the key characteristics found in cold hammer forged barrels. For many years, CZ has only offered cold hammer forged barrels with its firearms. As a result, this key component of every gun is ready for even the most demanding use. And because we have full confidence in our barrels, we are providing a lifetime barrel warranty for selected products. But first, let's take a closer look at how cold hammer forging works.



HOW DO WE MAKE OUR BARRELS?

The cold forging process involves a mandrel (a carbide rod with a mirror image of the rifling profile) being inserted into a polished hole in the barrel blank. The barrel is then placed in a "forging machine", a very precise machine that hammers the entire length of the blank using four specially designed and angled hammers made of sintered carbide or hardened steel. As a result of repeated blows by the hammer, the chamber, bore, and barrel rifling are formed around the mandrel with high dimensional precision and extremely tight tolerances. The hammers are also used to shape and extend the barrel to its final length.

ACTIVATE YOUR LIMITED LIFETIME WARRANTY TODAY!

And if the benefits of cold hammer forged barrels were not enough, CZ introduced a lifetime warranty in 2024 for the barrels of all firearms manufactured from 1 January 2019 onwards. The warranty not only covers any manufacturing defects, but also the loss of CZ barrel accuracy throughout their service life. If your barrel exhibits manufacturing defects or a reduction in accuracy, it will be repaired or replaced free of charge. In the event that repair or replacement is not possible, you will receive a purchase voucher in the amount of the barrel's suggested retail price.



Activating the warranty is easy, just sign up for the CZ customer club via **QR code** or go to <https://club.czguns.com/>.

But that's not all! In the customer club, you can also create your own online shooting diary, keep up with the latest information from the world of CZ, and download the manual for your gun. You can even use it to contact our customer support.

We look forward to welcoming you to the club!

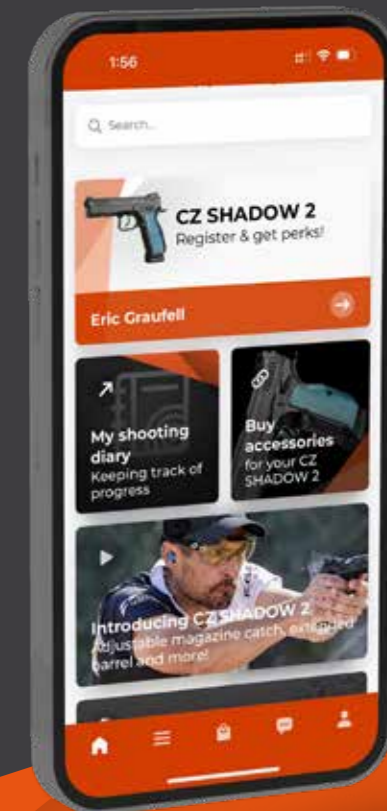

PISTOLS



CZ leads the world with a comprehensive line of advanced pistols that sees continuous innovation and expansion of models. We have an ideal firearm for everyone. All categories are covered, from supercompacts to full-size models and sport specials. Pistols within the different series are made from both traditional and modern, cutting edge materials with a selection of hammer-fired and striker-fired models. Keeping with the latest trends, selected models come ready for the installation of a suppressor and/or red dot sight.

THE MOST POPULAR FIREARMS FOR COMPETING IN THE IPSC PRODUCTION DIVISION

The CZ SHADOW 2 series is a family of high performance, large-capacity steel pistols for today's dynamic sport shooting disciplines. Models within this series allow good shooters to perform extremely well and the best shooters to win the most prestigious IPSC competitions.



CHOICE OF
ERIC GRAUFFEL (FRA)

CZ SHOOTING TEAM
NINE-TIME IPSC WORLD CHAMPION
WINNER OF 2024 USPSA CARRY OPTICS NATIONALS
USER OF CZ SHADOW 2

CZ SHADOW 2 SERIES

MAIN FEATURES OF THE
CZ SHADOW 2
SERIES



Ergonomic, deep-seated grip for improved control during shooting



Height and side-to-side adjustable rear sight for easy aiming



Adjustable magazine release button for maximum reloading speeds



1mm fiber optic front sight ensures high visibility and speeds up precise aiming



Cold hammer forged barrel



Extended left safety button also serves as thumb rest (CZ SHADOW 2 SA and CZ SHADOW 2 ORANGE)



Smooth trigger pull and shortened reset



CZ SHADOW 2 TARGET BULLSEYE EVERY TIME

Every shot requires complete concentration. Your heart beats faster, breathing slows and mind focuses only on the target. Each shot counts. Breath in, aim, fire.

THE FIREARM OF WINNERS

The CZ SHADOW 2 is a true legend. It has several IPSC World Championship titles and many international championship medals under its belt, along with tens of thousands of satisfied shooters who all benefit from its timeless and perfectly balanced design. The combination of speed, accuracy, and shooting comfort allows sport shooters to achieve top results. In fact, it's difficult to find a worthy rival when it comes to competing in dynamic disciplines. And now, CZ introduces a special model for target shooting enthusiasts. Bullseye collectors that can rely on the same qualities as their IPSC counterparts.

CZ SHADOW 2 TARGET

The philosophy of the CZ SHADOW 2 TARGET is based on complete customization to each shooter's needs. The high level of adjustability available to the user is key. This goes hand in hand with an emphasis on tight tolerances that result in absolute accuracy. We firmly believe that we have succeeded in designing a gun that satisfies the most demanding criteria. Judge for yourself.

Polished barrel in two lengths

If any component of a gun could be

considered absolutely crucial, it's definitely the barrel. Cold hammer forged barrels have been a mainstay in the CZ portfolio for many decades. During that time, we have fine-tuned the technology in their production. As a result, you can full rely on the high-quality barrel in the new CZ SHADOW 2 TARGET pistol, which comes with a lifetime barrel warranty against wear and manufacturing defects.

Five and six-inch polished barrels are ideal lengths for target shooting. At first glance, the precise, sharp-edged muzzle that's protected against damage by a crown is sure to catch your eye.

All key components, such as the barrel, slide and frame, are hand-fitted, which is a matter of course with all Orange flagship models - the guns of world champions. The CZ SHADOW 2 TARGET will therefore meet the most demanding requirements and is ready to compete straight "out of the box". And win!

Redesigned ergonomics

The slide on the CZ SHADOW 2 TARGET has been noticeably lengthened, especially in the 6-inch version, which has led to a longer sight radius. This is absolutely crucial for target shooting.

The cocking serrations on the front and rear of the slide have also undergone a change. They are now longer and deeper. A slightly less noticeable, but more significant, change is the modified shape of the trigger guard, which features an enlarged undercut. As a result, the grip is slightly higher and more comfortable.

The attractive look and grip of the CZ SHADOW 2 TARGET is supported by ergonomic grip panels, which feature sophisticated texturing that matches the roughened areas on the front and rear of the grip. The most striking change to the frame, however, is probably the trigger. The well-known adjustability of the take-up and over-travel found in existing CZ SHADOW 2 models is, of course, retained in the CZ SHADOW 2 TARGET. However, it is now possible to adjust trigger pull between 6-17 N, so it can be fine-tuned to the shooter and various shooting disciplines.

Another new feature is the trigger shoe, which fully adjusts to the shooter's hand. Thanks to its ingenious design, the trigger shoe can be quickly and easily adjusted to fit with the reach of any hand. Simply choose one of the 5 positions, adjust the trigger, and you're done!

The design of the controls has been optimized for target shooting. Even the front part of the frame hasn't escaped change, as the mounting rail for attaching accessories has been replaced by an interface for attaching a frame weight, which helps reduce muzzle rise. This is especially important in disciplines where speed is crucial, in addition to accuracy. With the CZ SHADOW 2 TARGET, you will also reign supreme in shooting speed.

Adjustable sights

For accurate target shooting, it is absolutely crucial to have the right sights. The fully adjustable target rear sight, from the renowned manufacturer LPA, is adjustable in both the horizontal and vertical axes. Combined with a target front sight that comes in two different widths, shooters can fine-tune the sights to their exact liking.

Ready to dominate! Are you?

The CZ SHADOW 2 TARGET continues in CZ's tradition of creating firearms for success in dynamic shooting. You will arrive at every competition equipped with a pistol that shares DNA with champions. The CZ SHADOW 2 TARGET is ready to dominate! Are you?

NEW

CZ SHADOW 2 TARGET 6"

The philosophy of the CZ Shadow 2 Target is based on complete customization to each shooter's needs. The high level of adjustability available to the user is key. This goes hand in hand with an emphasis on tight tolerances resulting in absolute accuracy. Introducing the new features that will put a new trophy on your shelf. Really!



NEW

CZ SHADOW 2 TARGET 5"

The philosophy of the CZ Shadow 2 Target is based on complete customization to each shooter's needs. The high level of adjustability available to the user is key. This goes hand in hand with an emphasis on tight tolerances resulting in absolute accuracy. Introducing the new features that will put a new trophy on your shelf. Really!



MODEL	CALIBER	MAGAZINE CAPACITY	WEIGHT with empty magazine (g)	DIMENSIONS L x W x H (mm)	BARREL LENGTH (mm)	SIGHTS	THREAD	TRIGGER PULL (N)	TRIGGER TRAVEL (mm)	TRIGGER RESET (mm)	FRAME	GRIPS	SAFETY FEATURES
CZ SHADOW 2 TARGET 6"	9 x 19	17	1285	248 x 45 x 143	153	Plain black front sight, Fully adjustable rear sight	-	SA: 5-20	3-4	3-4	Steel	G 10	Manual safety, Safety notch on the hammer
CZ SHADOW 2 TARGET 5"	9 x 19	17	1245	217 x 45 x 143	122	Plain black front sight, Fully adjustable rear sight	-	SA: 5-20	3-4	3-4	Steel	G 10	Manual safety, Safety notch on the hammer

NEW

CZ SHADOW 2 COMPACT

The CZ SHADOW 2 COMPACT is an ideal compact size pistol for users and fans of the CZ SHADOW 2. With a partial reduction in size, and a significant reduction in weight, it retains all of the key strengths of the series, which are led by the shooting comfort and accuracy that have made the CZ SHADOW 2 pistol a winner at the world's most prestigious championships.



The CZ SHADOW 2 COMPACT is not only the perfect choice for sport shooting, but also for all-day carry, including concealed carry. Its range of use is further expanded with a mounting interface, compatible with CZ SHADOW 2 OR pistols, for attachment of a red dot sight.



**COMPACT
LIGHT-WEIGHT
PURE PERFORMANCE**

MODEL	CALIBER	MAGAZINE CAPACITY	WEIGHT with empty magazine (g)	DIMENSIONS L x W x H (mm)	BARREL LENGTH (mm)	SIGHTS	THREAD	TRIGGER PULL (N)	TRIGGER TRAVEL (mm)	TRIGGER RESET (mm)
CZ SHADOW 2 COMPACT	9 x 19	15	900	191 x 35 x 138	102	Fiber optic front sight, Checkered rear sight	-	SA: 15 DA: 46	SA: 3-4 DA: 12	3-4

FRAME	GRIPS	SAFETY FEATURES
Forged aluminum alloy	Duralumin	Manual safety, Safety notch on the hammer

NEW

CZ SHADOW 2 ORANGE OR

An advanced, innovative sport pistol design that elevates your shooting experience and results in competitions to the highest level. The superb design base of this model has been further improved by precise gunsmithing modifications and the use of top-quality sport shooting components. A new feature is an extremely low and highly durable interface for mounting today's compact red dot sights.



PRODUCTION



PRODUCTION OPTICS



ERIC GRAUFFEL

used the **CZ SHADOW 2** to win multiple titles in the Production division:

WORLD CHAMPIONSHIP TITLE AT THE 2022 IPSC HANDGUN WORLD SHOOT IN PATTAYA, THAILAND

EUROPEAN CHAMPIONSHIP TITLE AT THE 2023 EUROPEAN HANDGUN CHAMPIONSHIP IN CORINTH, GREECE

CZ SHADOW 2 OR

The CZ SHADOW 2 pistol is extremely fast, yet at some shooting stages, it can be even faster. How is that possible? By using today's compact red dot sights. The OR (Optics-Ready) model allows for their easy, exceptionally low and secure attachment.



PRODUCTION OPTICS



Red dot sight is not included in the package.

MODEL	CALIBER	MAGAZINE CAPACITY	WEIGHT with empty magazine (g)	DIMENSIONS L x W x H (mm)	BARREL LENGTH (mm)	SIGHTS	THREAD	TRIGGER PULL (N)	TRIGGER TRAVEL (mm)	TRIGGER RESET (mm)	FRAME	GRIPS	SAFETY FEATURES
CZ SHADOW 2 ORANGE OR	9 x 19	19	1330	217 x 42 x 157	120	Fiber optic front sight, Checkered rear sight	-	SA: 15 DA: 46	SA: 3-4 DA: 12	3-4	Steel	Duralumin	Manual safety, Safety notch on the hammer
CZ SHADOW 2 OR	9 x 19	19	1330	217 x 34 x 157	120	Fiber optic front sight, Checkered rear sight	-	SA: 15 DA: 46	SA: 3-4 DA: 12	3-4	Steel	Duralumin	Manual safety, Safety notch on the hammer



CZ SHADOW 2 SA

A target shooting model of the successful sports special with a single-action trigger mechanism and adjustable trigger designed to achieve the most accurate hits.

CZ SHADOW 2

The CZ Shadow 2 is an all-steel, large-capacity SA | DA pistol that is currently the most celebrated firearm in today's dynamic sport disciplines. This model is used by winners of the most prestigious IPSC shooting competitions.



PRODUCTION

CZ SHADOW 2 URBAN GREY

Traditional black is not the only color that suits sport. Our portfolio therefore includes a model whose frame is coated with a highly durable finish in the trendy and popular Urban Grey color scheme, which beautifully contrasts with the black aluminum grips.



PRODUCTION

MODEL	CALIBER	MAGAZINE CAPACITY	WEIGHT with empty magazine (g)	DIMENSIONS L x W x H (mm)	BARREL LENGTH (mm)	SIGHTS	THREAD	TRIGGER PULL (N)	TRIGGER TRAVEL (mm)	TRIGGER RESET (mm)	FRAME	GRIPS	SAFETY FEATURES
CZ SHADOW 2 SA	9 x 19	19	1330	217 x 42 x 157	120	Fiber optic front sight, Checkered rear sight	-	SA: 15	3-4	3-4	Steel	Duralumin	Manual safety, Safety notch on the hammer
CZ SHADOW 2	9 x 19, 380 Auto	19 / 10, 18	1330	217 x 34 x 157	120	Fiber optic front sight, Checkered rear sight	-	SA: 15 DA: 46	SA: 3-4 DA: 12	3-4	Steel	Duralumin	Manual safety, Safety notch on the hammer
CZ SHADOW 2 URBAN GREY	9 x 19	19	1330	217 x 34 x 157	120	Fiber optic front sight, Checkered rear sight	-	SA: 15 DA: 46	SA: 3-4 DA: 12	3-4	Steel	Duralumin	Manual safety, Safety notch on the hammer



B0101-0013
SHIELD RMS (AL) RED DOT SIGHT

1091-1420-06
CZ SHADOW OPTICS-READY PLATE –
SHIELD RMS

1091-1335
WIDE SAFETY SET
CZ SHADOW 2, CZ TS, CZ TS 2

B0305-0000
AL MAG RELEASE BUTTON
CZ SHADOW 2 COMPACT, BLUE

B0305-0005
CZ SHADOW 2 COMPACT
GRIPS, BLUE

B0306-0007
AL MAG BOTTOM +2RND
CZ SHADOW 2 COMPACT, BLUE



3700-7700
TRIJICON RMR RM06-C-700688
RED DOT SIGHT

1091-1420-01
CZ SHADOW OPTICS-READY PLATE –
RMR/SRO

1091-1335
WIDE SAFETY SET
CZ SHADOW 2, CZ TS, CZ TS 2

1091-1311-03
TARGET TRIGGER, RED

1091-2180-11
CZ SHADOW 2 GRIPS,
BLACK (HARD ELOX)

1091-1346-03
ALU 19 R. BASE PLATE, RED

**RECOMMENDED
ACCESSORIES**

A NEW GENERATION OF SA SPORT PISTOLS OPTIMIZED FOR THE IPSC STANDARD DIVISION

Since 2005, the TS – TACTICAL SPORTS label has been given to top sports specials based on the legendary CZ 75 model. The CZ TS 2 series is the result of development activities that draw upon the extensive experience of CZ Shooting Team, together with today's most advanced design principles and manufacturing processes.

 KHLIL
VIRAY

CHOICE OF
KAHLIL ADRIAN VIRAY (PHL)

IPSC WORLD CHAMPION
CZ SHOOTING TEAM
CZ TS 2 ORANGE USER

CZ TS 2
SERIES

MAIN FEATURES OF THE
CZ TS 2 SERIES



Height adjustable metal rear sight (CZ TS 2 DEEP BRONZE, CZ TS 2 RACING GREEN and CZ TS 2 ORANGE)



1 mm red fiber optic front sight for quick and intuitive aiming



Attractive design of the slide, frame and sport hammer



Extended manual safety on left side



Single-Action (SA) only trigger mechanism with short travel and quick reset



Improved ergonomics contribute for extreme shooting comfort

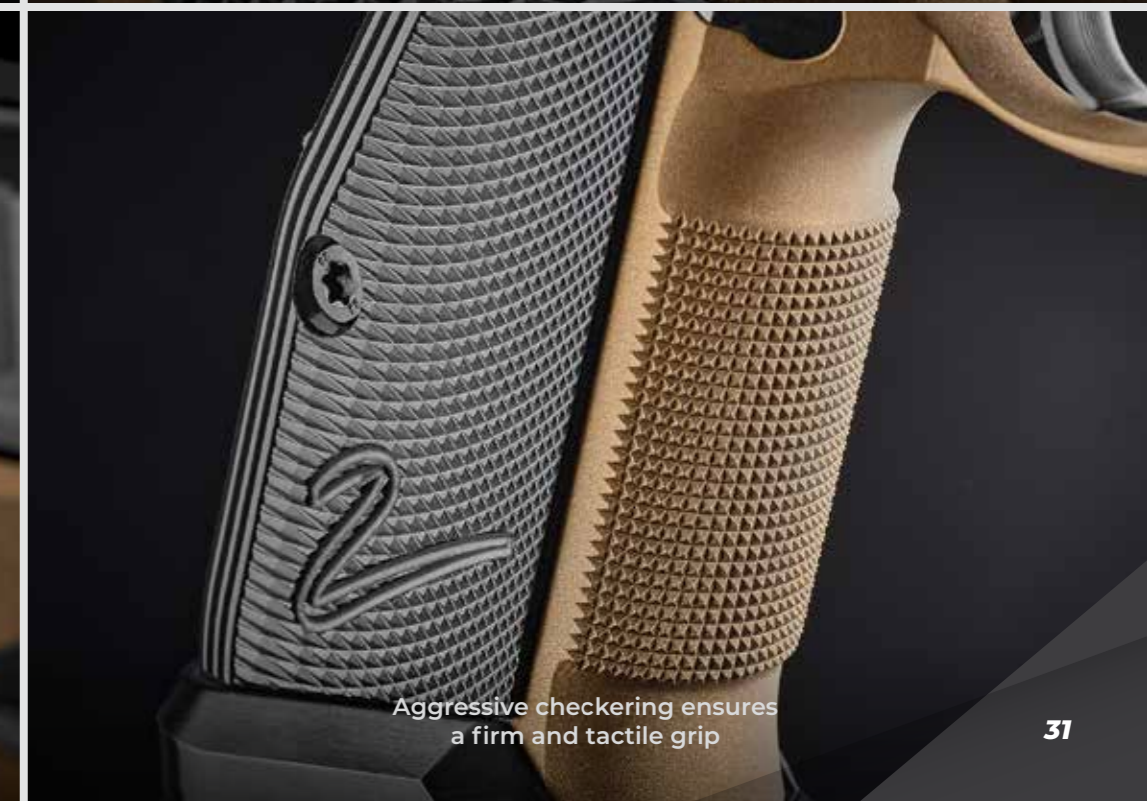

Aggressive checkering ensures a firm and tactile grip

CZ TS 2 ORANGE

ORANGE



A sport special developed in accordance with the latest trends in the IPSC Standard division. Its main, new feature is a heavy polished barrel, which has a number of advantages, chief among them more control during very quick, repetitive shots. Extra cocking serrations are placed on the top edge of the slide.



**CHOICE OF
KAHLIL ADRIAN VIRAY**

**STANDARD DIVISION
WORLD CHAMPION AT 2022 IPSC
HANDGUN WORLD SHOOT
PATTAYA, THAILAND**

The barrel-to-slide and slide-to-frame are hand-fitted to achieve the smallest possible tolerances for optimized operation. This model also comes with a thin profile thumb rest with ideal placement, higher positioned ambidextrous manual safeties and an adjustable rear sight. The duralumin grips, adjustable magazine release button, magwell and magazine base plate are made from orange anodized duralumin.



STANDARD

**A NEW LEVEL
OF ACCURACY
AND SPEED**

MODEL	CALIBER	MAGAZINE CAPACITY	WEIGHT with empty magazine (g)	DIMENSIONS L x W x H (mm)	BARREL LENGTH (mm)	SIGHTS	THREAD	TRIGGER PULL (N)	TRIGGER TRAVEL (mm)	TRIGGER RESET (mm)	FRAME	GRIPS	SAFETY FEATURES
CZ TS 2 ORANGE	9 x 19	20 / 10	1470	225 x 45 x 149	130	Fiber optic front sight, Checkered rear sight	-	SA: 8	3-4	3-4	Steel	Duralumin	Manual safety, Safety notch on the hammer
CZ TS 2 ORANGE	40 S&W	17	1460	225 x 45 x 149	130	Fiber optic front sight, Checkered rear sight	-	SA: 8	3-4	3-4	Steel	Duralumin	Manual safety, Safety notch on the hammer



CZ TS 2 DEEP BRONZE

A sport special with hand-fitted, custom components for competing in the IPSC Standard Division. It features a Deep Bronze finished frame and polished barrel. The flat grips, magazine base and adjustable magazine release are made from black anodized duralumin. A flat slide release and thumb rest come as standard.



STANDARD

CZ TS 2 RACING GREEN

A more advanced design of the sport special for the IPSC Standard Division with flat, green anodized duralumin grips and magazines with green anodized base plates. Advanced features include increased user comfort, a height adjustable rear metal sight, a thumb rest, a flat slide stop and an adjustable, green anodized magazine release button.



STANDARD

CZ TS 2

Base model of the sport special for competing in the IPSC Standard Division or for target shooting. This model, which was developed together with members of the CZ Shooting Team, is equipped with flat, silver anodized duralumin grips, fixed metal sights and an extended, manual safety on the left side of the pistol (flat safety on the right side). The most affordable version in the series, it stands out for extreme shooting comfort and high accuracy.



STANDARD

MODEL	CALIBER	MAGAZINE CAPACITY	WEIGHT with empty magazine (g)	DIMENSIONS L x W x H (mm)	BARREL LENGTH (mm)	SIGHTS	THREAD	TRIGGER PULL (N)	TRIGGER TRAVEL (mm)	TRIGGER RESET (mm)
CZ TS 2 DEEP BRONZE	9 x 19	20 / 10	1350	225 x 42 x 149	130	Fiber optic front sight, Height adjustable visor –		SA: 8	3–4	3–4
CZ TS 2 RACING GREEN	9 x 19	20 / 10	1350	225 x 42 x 149	130	Fiber optic front sight, Height adjustable visor –		SA: 8	3–4	3–4
CZ TS 2	9 x 19	20	1350	225 x 42 x 149	130	Fiber optic front sight, Height adjustable visor –		SA: 8	3–4	3–4

FRAME	GRIPS	SAFETY FEATURES
Steel	Duralumin	Manual safety, Safety notch on the hammer
Steel	Duralumin	Manual safety, Safety notch on the hammer
Steel	Duralumin	Manual safety, Safety notch on the hammer



RELIABLE STRIKER-FIRED PISTOL SERIES WITH POLYMER FRAME

The industry-leading CZ P-10 series is offered in a comprehensive array of sizes, from subcompact (CZ P-10 S), compact (CZ P-10 C) and full-size (CZ P-10 F). Most models are also available with a design that allows for the easy installation of a suppressor and/or red dot sight.

All CZ P-10 series pistols feature maximum reliability, high accuracy, a long service life and shooting comfort. The sophisticated grip and checkering were created in accordance with the innovative DiFEND ergonomic methodology, which significantly contributes to extreme user-friendliness. The very first model released in this series, the CZ P-10 C compact, was named “2017 Gun of the Year” by the prestigious American magazine “Guns & Ammo”.

CZ P-10
SERIES

MAIN FEATURES OF THE
CZ P-10 SERIES



Extremely durable and weather resistant finish on slide and barrel



Front and rear cocking serrations for comfortable and safe handling



Lightweight and durable fiberglass-reinforced polymer frame is mechanically strong and thermally stable



Flat ambidextrous slide stop

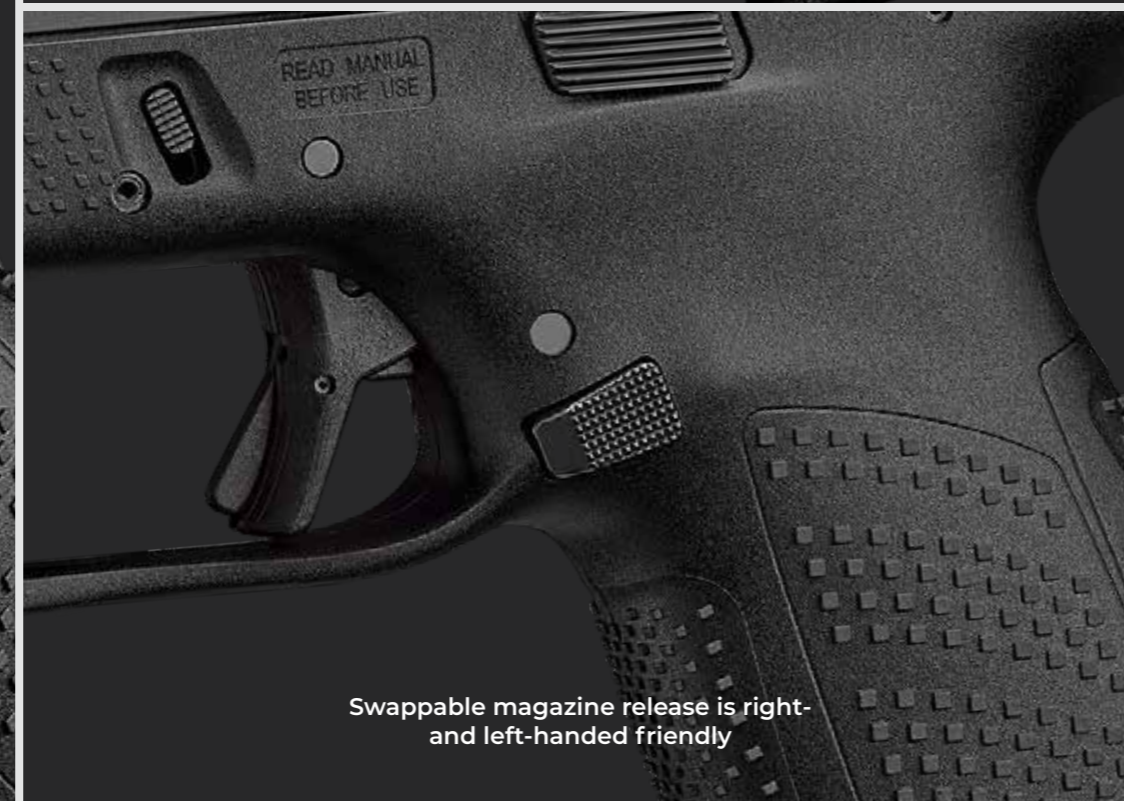

Swappable magazine release is right- and left-handed friendly

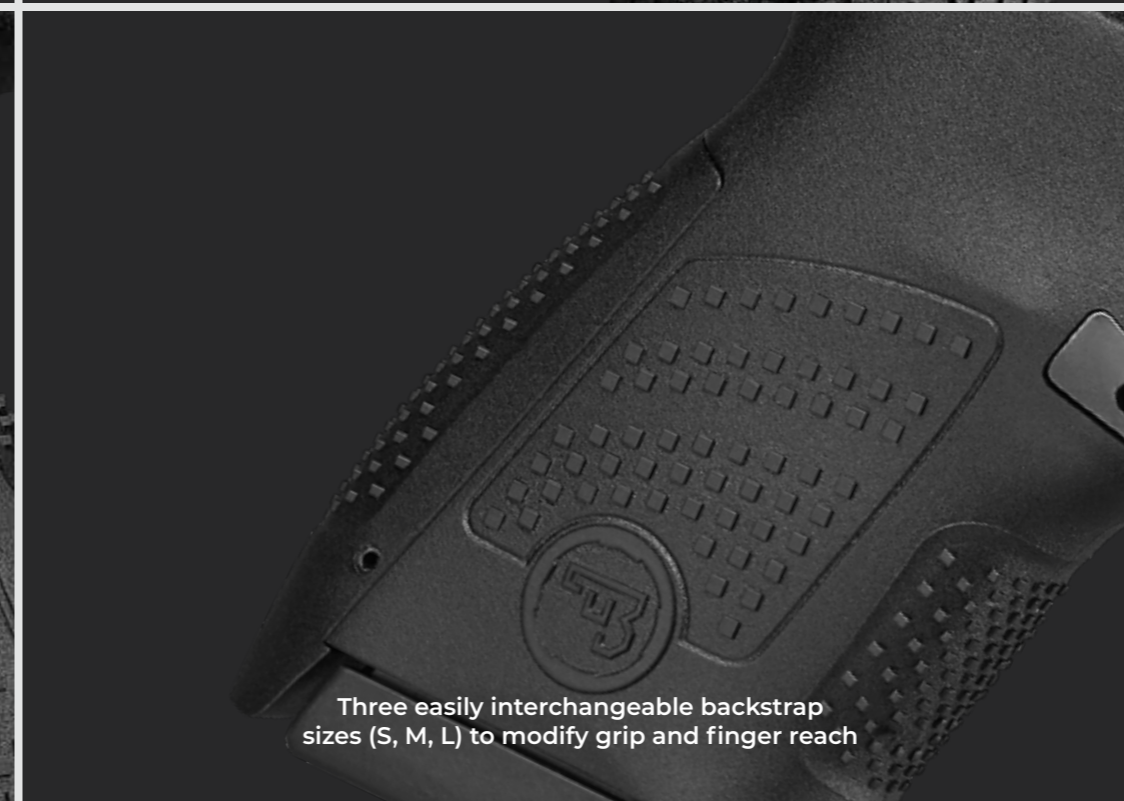

Three easily interchangeable backstrap sizes (S, M, L) to modify grip and finger reach



Ergonomic grip with prominent checkering for superb shooting comfort, stability and safety

NEW

CZ P-10 F OR 45 AUTO

The CZ P-10 F in the iconic .45 ACP, delivering the classic, hard-hitting power you know and trust, is now available in the OR version. Designed for those who demand performance and precision, this full-size pistol features a red dot cut, allowing you to mount your favorite optic. Combining the legendary stopping power of .45 ACP with the modern advantage of a red dot sight, the P-10 F sets a new standard for accuracy, speed, and versatility. This is the .45 ACP you love, evolved for today's shooter.



Red dot sight is not included in the package.



Red dot sight is not included in the package.

CZ P-10 F OR SR

The CZ P-10 F OR SR (Optics-Ready-Suppressor-Ready) features both an innovative CZ interface for mounting a red dot sight and extended barrel with 1/2" x 28 UNEF – 3A threads for mounting a suppressor. This model allows for more flexible use and offers a higher level of shooting comfort.



Red dot sight is not included in the package.

CZ P-10 F OR

The CZ P-10 F OR (Optics-Ready) has been designed for the increasingly popular option of mounting a red dot sight quickly and easily. The innovative CZ mounting interface is known for its robustness, strength, durability, low installation height and easy aiming with the red dot sight at short to long distances. This model also comes with high (cowitness) iron sights in case optics are damaged or fail.

MODEL	CALIBER	MAGAZINE CAPACITY	WEIGHT with empty magazine (g)	DIMENSIONS L x W x H (mm)	BARREL LENGTH (mm)	SIGHTS	THREAD	TRIGGER PULL (N)	TRIGGER TRAVEL (mm)	TRIGGER RESET (mm)
CZ P-10 F OR 45 AUTO	.45 Auto	13	930	207 x 34 x 153	114	Luminescent	No	25±4	9±1	4
CZ P-10 F OR	9 x 19	19	810	203 x 32 x 153	114	Luminescent	No	25±4	9±1	4
CZ P-10 F OR SR	9 x 19	19	830	225 x 32 x 153	134	Luminescent	1/2" x 28 UNEF – 3A	25±4	9±1	4

FRAME	GRIPS	SAFETY FEATURES
Fiberglass-reinforced polymer	–	Trigger safety, Trigger bar safety, Firing pin block
Fiberglass-reinforced polymer	–	Trigger safety, Trigger bar safety, Firing pin block
Fiberglass-reinforced polymer	–	Trigger safety, Trigger bar safety, Firing pin block

NEW

CZ P-10 C OR FDE

The CZ P-10 C OR is now available in the highly sought-after FDE (Flat Dark Earth) color, combining tactical style with top-tier performance. This optics-ready pistol maintains the superior ergonomics, reliability, and precision the P-10 series is known for, now enhanced with a rugged and versatile finish perfect for any environment. Elevate your shooting experience with a firearm that's as bold in appearance as it is in capability!



Red dot sight is not included in the package.



Red dot sight is not included in the package.



Red dot sight is not included in the package.

CZ P-10 C OR

The OR (Optics-Ready) model comes with a modified slide for easy attachment of a red dot sight. This innovative solution from CZ is characterized by its strong and durable assembly, low mounting height, easy aiming with a red dot sight (even at long distances), and the option to use iron sights in the event of the optics failing.

CZ P-10 C

Due to its compact dimensions, innovative design and large firing capacity, this highly advanced, striker-fired pistol is suitable for concealed carry.

CZ P-10 C OR SR

The CZ P-10 C OR SR (Optics-Ready-Suppressor-Ready) features both a slide with an innovative interface for mounting a red dot sight and an extended barrel with 1/2" x 28 UNEF – 3A threads for mounting a suppressor. This model allows for quicker target acquisition and provides a higher level of shooting comfort.

MODEL	CALIBER	MAGAZINE CAPACITY	WEIGHT with empty magazine (g)	DIMENSIONS L x W x H (mm)	BARREL LENGTH (mm)	SIGHTS	THREAD	TRIGGER PULL (N)	TRIGGER TRAVEL (mm)	TRIGGER RESET (mm)	FRAME	GRIPS	SAFETY FEATURES
CZ P-10 C	9 x 19, 380 Auto	15	740	187 x 32 x 132	102	Luminescent	No	25±4	9±1	4	Fiberglass-reinforced polymer	-	Trigger safety, Trigger bar safety, Firing pin block
CZ P-10 C OR	9 x 19	15	740	187 x 32 x 135	102	Luminescent	No	25±4	9±1	4	Fiberglass-reinforced polymer	-	Trigger safety, Trigger bar safety, Firing pin block
CZ P-10 C OR FDE	9 x 19	15	740	187 x 32 x 135	102	Luminescent	No	25±4	9±1	4	Fiberglass-reinforced polymer	-	Trigger safety, Trigger bar safety, Firing pin block
CZ P-10 C OR SR	9 x 19	15	760	209 x 32 x 135	122	Luminescent	1/2" x 28 UNEF – 3A	25±4	9±1	4	Fiberglass-reinforced polymer	-	Trigger safety, Trigger bar safety, Firing pin block



Red dot sight is not included in the package.



CZ P-10 S OR

The industry-leading CZ P-10 series is available in a comprehensive range of sizes, from the subcompact CZ P-10 S and the compact CZ P-10 C, to the full-size CZ P-10 F.

MODEL	CALIBER	MAGAZINE CAPACITY	WEIGHT with empty magazine (g)	DIMENSIONS L x W x H (mm)	BARREL LENGTH (mm)	SIGHTS	THREAD	TRIGGER PULL (N)	TRIGGER TRAVEL (mm)	TRIGGER RESET (mm)
CZ P-10 S OR	9 x 19	12	710	170 x 32 x 119	89,5	Luminescent	No	25±4	9±1	4

FRAME	GRIPS	SAFETY FEATURES
Fiberglass-reinforced polymer	-	Trigger safety, Trigger bar safety, Firing pin block



B0103-0002
STREAMLIGHT TLR-8 A LIGHT
(RED LASER)

B0103-0001
STREAMLIGHT TLR-7 A LIGHT SML69424

B0103-0003
STREAMLIGHT TLR-8 G LIGHT (GR. LASER)

RECOMMENDED
ACCESSORIES



THIRD GENERATION OF THE SUCCESSFUL POLYMER PISTOL SERIES WITH THE OMEGA SA/DA TRIGGER MECHANISM

The new CZ P-09 NOCTURNE F (Full-size) and C (Compact) models not only retain all key features of the previous CZ P-07/09 generation, but in some ways takes them even further. It comes with improved ergonomics, the ability to mount a red dot sight without a plate, and controls that further expand the features found in the CZ P-09 series.



CZ P-09
NOCTURNE
SERIES

MAIN FEATURES OF THE
CZ P-09 NOCTURNE
SERIES



New Optics-Ready interface compatible with Shield RMS and Holosun K footprints



Enhanced front cocking serrations



Extremely durable nitride finish on slide and barrel - BOBOX

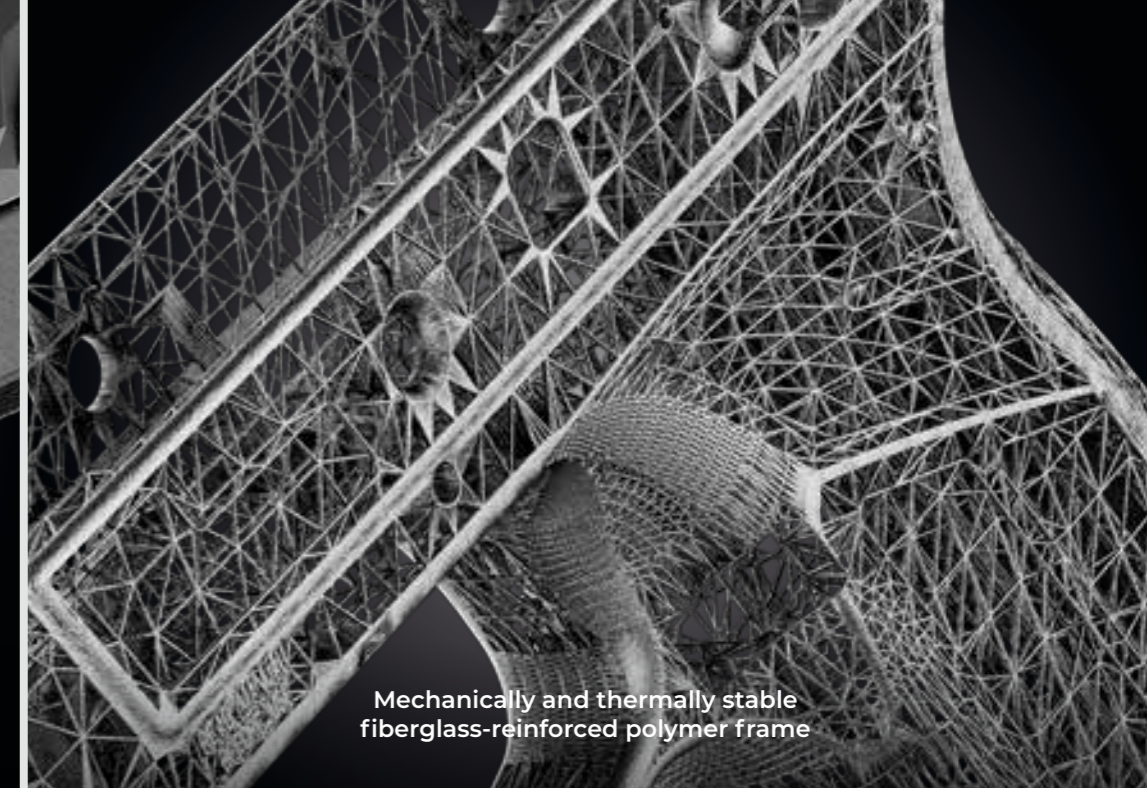

Mechanically and thermally stable fiberglass-reinforced polymer frame



Interchangeable, ambidextrous safety levers, manual safety to decocker



Omega SA/DA trigger mechanism



Three sizes of interchangeable backstraps to modify grip



CZ P-09 NOCTURNE INNOVATION WITHOUT COMPROMISE

Synergy between shooters and their guns is crucial. To achieve this goal, a firearm must provide maximum shooting comfort. When developing new products, CZ draws on its decades of experience to make a firearm as reliable, accurate, durable and user-friendly as possible.

Although most shooters mainly require striker-fired pistols, many still prefer a double-action trigger and hammer. CZ responded to these demands by coming with a hammer-fired pistol with a lightweight and durable polymer frame.

The release of the CZ P-07 sixteen years ago, the so-called DUTY that was based on the iconic CZ 75 pistol, was followed by a second generation in 2013. The full-size CZ P-09 was released that same year and became a bestseller.

Since that time, CZ has remained a leader in the industry and consistently responded to evolving demands from customers. Case in point is the introduction of the upgraded version of the CZ P-09 – the CZ P-09 NOCTURNE!

MODIFICATIONS WITHOUT LIMITS

A frequent request from CZ P-07 and CZ P-09 users was the possibility of mounting a red dot sight. We answered their call with the new CZ P-09 NOCTURNE. Unlike CZ P-10 OR and CZ SHADOW 2 OR pistols, red dot sights with the Shield RMS mounting interface can be mounted directly on the gun. Optics therefore have a lower profile, while maintaining co-witness.

The fixed sights feature luminescent dots for more intuitive shooting. A tritium sight version will be available for selected markets. After all, the NOCTURNE should be able to see at night.

If you shoot without a red dot sight, the rear sight has been designed for emergency cocking against a suitable surface. Traditional MIL-STD-1913 rails allow you to mount a tactical flashlight, laser sight or other accessories.

EVERYTHING IS GEARED FOR HIGH COMFORT

Advanced ergonomics are critical for shooting accurately. We have therefore combined the optimum grip angle with a new texturing for a firm and secure grip in all conditions. This texturing has also been extended to the area

between the trigger guard and beaver tail, in front of the slide catch/release lever on both sides of the frame, and on the magazine base. Further fine-tuning of the grip is possible with three sizes of interchangeable backstraps. Controls have also changed with a new shape of the slide catch/release lever, manual safety, and decocker for more intuitive and confident operation. A further change is enhanced cocking serrations added to the front of the slide for a more secure grip during press checks.

SUPERB TRIGGER PULL IN BOTH MODES

Simplified construction of the Omega's trigger mechanism, based on the CZ 75 system, adds the option of a user-replaceable trigger release safety, the so-called decocker. The trigger features butter smooth pull with a crisp break in both modes. The shape of the trigger blade and spacious combat trigger guard allow for comfortable shooting, even with gloves on.

THE BENCHMARK OF RELIABILITY

The CZ P-09 NOCTURNE was put through several extremely demanding tests according to NATO AC/225 D/14 to ensure reliable operation in the most challenging conditions,

such as high and low temperatures, salt water, sand, mud and dust. It passed with flying colors.

DURABILITY THAT ENSURES AN EXTENDED SERVICE LIFE

All metal components have a high-quality finish. Nitriding of the slide, barrel, container and other components ensures maximum resistance to corrosion.

Durability is further ensured by a barrel manufactured with CZ's advanced cold hammer forging technology and comes with a lifetime warranty. It is not only extremely durable, but also highly accurate. The tough, fiberglass-reinforced polymer frame is extremely strong and resistant to temperature fluctuations, ensuring reliable operation in the most adverse conditions.

BOTTOM LINE

Whether you need a firearm that is shooter-friendly for recreational use, comfortable for everyday carry, or reliable and durable in the most demanding conditions, the CZ P-09 NOCTURNE handles them all. Without compromise.

NEW

CZ P-09 F NOCTURNE

The full-size version of the CZ P-09 NOCTURNE with OMEGA SA/DA trigger mechanism features advanced ergonomics and intuitive placement of controls for maximum comfort with intuitive operation. High accuracy is ensured by its full-size, cold hammer forged barrel and luminescent or tritium sights. New texturing on the grip and other strategic areas provide high traction where you need it most.



Red dot sight is not included in the package.

NEW

CZ P-09 F NOCTURNE SR

The Suppressor-Ready (SR) version of the full-size comes with a 1/2" x 28 UNEF-3A threaded barrel for quick and easy mounting of a suppressor. High performance doesn't need to raise its voice.



Red dot sight is not included in the package.



NEW

CZ P-09 C NOCTURNE

The reduced, compact dimensions of the CZ P-09 NOCTURNE C make it the perfect choice for concealed carry. Although smaller than the full-size version, it retains the same cutting-edge features, intuitive operation and extreme shooting comfort.



Red dot sight is not included in the package.

NEW

CZ P-09 C NOCTURNE SR

Concealed carry with a whisper is a fitting description for the CZ P-09 C NOCTURNE SR (Suppressor-Ready). Its reduced dimensions are complimented by a 1/2" x 28 UNEF-3A threaded barrel for fast and convenient mounting of a suppressor.



Red dot sight is not included in the package.

MODEL	CALIBER	MAGAZINE CAPACITY	WEIGHT with empty magazine (g)	DIMENSIONS L x W x H (mm)	BARREL LENGTH (mm)	SIGHTS	THREAD	TRIGGER PULL (N)	TRIGGER TRAVEL (mm)	TRIGGER RESET (mm)	FRAME	GRIPS	SAFETY FEATURES
CZ P-09 F NOCTURNE	9 x 19	19	830	208 x 37 x 150	115	Luminescent, Tritium	No	SA: 21 DA: 44±2	SA: 10±1 DA: 13±2	7±1	Fiberglass-reinforced polymer	-	Manual safety / decocker, Safety notch on hammer, Firing pin block
CZ P-09 F NOCTURNE SR	9 x 19	19	880	230 x 37 x 150	135	Luminescent, Tritium	1/2" x 28 UNEF - 3A	SA: 21 DA: 44±2	SA: 10±1 DA: 13±2	7±1	Fiberglass-reinforced polymer	-	Manual safety / decocker, Safety notch on hammer, Firing pin block
CZ P-09 C NOCTURNE	9 x 19	15	740	185 x 37 x 137	95	Luminescent, Tritium	No	SA: 21 DA: 44±2	SA: 10±1 DA: 13±2	7±1	Fiberglass-reinforced polymer	-	Manual safety / decocker, Safety notch on hammer, Firing pin block
CZ P-09 C NOCTURNE SR	9 x 19	15	760	207 x 37 x 137	115	Luminescent, Tritium	1/2" x 28 UNEF - 3A	SA: 21 DA: 44±2	SA: 10±1 DA: 13±2	7±1	Fiberglass-reinforced polymer	-	Manual safety / decocker, Safety notch on hammer, Firing pin block



KADET ADAPTERS

Complete kits for the easy and quick conversion of selected CZ large caliber pistols to fire 22 LR cartridges, ensuring maximum comfort and affording shooting. Assembly does not require any modifications. The basic kit always includes a 10-round magazine and a set of recoil springs to ensure reliable operation with all types of ammunition.

MODEL	CALIBER	MAGAZINE CAPACITY	WEIGHT with empty magazine (g)	BARREL LENGTH (mm)	SIGHTS
ADAPTER CZ SHADOW 2 KADET	22 LR	10	300	125	Checkered rear sight
ADAPTER CZ P-09 KADET	22 LR	10	300	120	Checkered rear sight
ADAPTER CZ P-07 KADET	22 LR	10	280	103	Checkered rear sight

ADAPTER

CZ SHADOW 2 KADET



ADAPTER

CZ P-09 KADET



ADAPTER

CZ P-07 KADET



MODEL	CALIBER	MAGAZINE CAPACITY	WEIGHT with empty magazine (g)	DIMENSIONS L x W x H (mm)	BARREL LENGTH (mm)	SIGHTS	THREAD	TRIGGER PULL (N)	TRIGGER TRAVEL (mm)	TRIGGER RESET (mm)	FRAME	GRIPS	SAFETY FEATURES
CZ SHADOW 2 TARGET 5"	9 × 19	17	1245	217 × 45 × 143	122	Plain black front sight, Fully adjustable rear sight	–	SA: 5-20	3-4	3-4	Steel	G 10	Manual safety, Safety notch on the hammer
CZ SHADOW 2 TARGET 6"	9 × 19	17	1285	248 × 45 × 143	153	Plain black front sight, Fully adjustable rear sight	–	SA: 5-20	3-4	3-4	Steel	G 10	Manual safety, Safety notch on the hammer
CZ SHADOW 2 COMPACT	9 × 19	15	900	191 × 35 × 138	102	Fiber optic front sight, Checkered rear sight	–	SA: 15 DA: 46	SA: 3-4 DA: 12	3-4	Forged aluminum alloy	Duralumin	Manual safety, Safety notch on the hammer
CZ SHADOW 2	9 × 19, 380 Auto	19 / 10, 18	1330	217 × 34 × 157	120	Fiber optic front sight, Checkered rear sight	–	SA: 15 DA: 46	SA: 3-4 DA: 12	3-4	Steel	Duralumin	Manual safety, Safety notch on the hammer
CZ SHADOW 2 OR	9 × 19	19	1330	217 × 34 × 157	120	Fiber optic front sight, Checkered rear sight	–	SA: 15 DA: 46	SA: 3-4 DA: 12	3-4	Steel	Duralumin	Manual safety, Safety notch on the hammer
CZ SHADOW 2 SA	9 × 19	19	1330	217 × 42 × 157	120	Fiber optic front sight, Checkered rear sight	–	SA: 15	3-4	3-4	Steel	Duralumin	Manual safety, Safety notch on the hammer
CZ SHADOW 2 ORANGE OR	9 × 19	19	1330	217 × 42 × 157	120	Fiber optic front sight, Checkered rear sight	–	SA: 15 DA: 46	SA: 3-4 DA: 12	3-4	Steel	Duralumin	Manual safety, Safety notch on the hammer
CZ SHADOW 2 URBAN GREY	9 × 19	19	1330	217 × 34 × 157	120	Fiber optic front sight, Checkered rear sight	–	SA: 15 DA: 46	SA: 3-4 DA: 12	3-4	Steel	Duralumin	Manual safety, Safety notch on the hammer
CZ TS 2 ORANGE	9 × 19	20 / 10	1470	225 × 45 × 149	130	Fiber optic front sight, Checkered rear sight	–	SA: 8	3-4	3-4	Steel	Duralumin	Manual safety, Safety notch on the hammer
CZ TS 2 ORANGE	40 S&W	17	1460	225 × 45 × 149	130	Fiber optic front sight, Checkered rear sight	–	SA: 8	3-4	3-4	Steel	Duralumin	Manual safety, Safety notch on the hammer
CZ TS 2 DEEP BRONZE	9 × 19	20 / 10	1350	225 × 42 × 149	130	Fiber optic front sight, Height adjustable visor	–	SA: 8	3-4	3-4	Steel	Duralumin	Manual safety, Safety notch on the hammer
CZ TS 2 RACING GREEN	9 × 19	20 / 10	1350	225 × 42 × 149	130	Fiber optic front sight, Height adjustable visor	–	SA: 8	3-4	3-4	Steel	Duralumin	Manual safety, Safety notch on the hammer
CZ TS 2	9 × 19	20	1350	225 × 42 × 149	130	Fiber optic front sight, Height adjustable visor	–	SA: 8	3-4	3-4	Steel	Duralumin	Manual safety, Safety notch on the hammer
CZ P-10 F OR	9 × 19	19	810	203 × 32 × 153	114	Luminescent	No	25±4	9±1	4	Fiberglass-reinforced polymer	–	Trigger safety, Trigger bar safety, Firing pin block
CZ P-10 F OR SR	9 × 19	19	830	225 × 32 × 153	134	Luminescent	1/2" × 28 UNEF – 3A	25±4	9±1	4	Fiberglass-reinforced polymer	–	Trigger safety, Trigger bar safety, Firing pin block
CZ P-10 F 45 Auto	45 Auto	13	930	207 × 34 × 153	114	Luminescent	No	25±4	9±1	4	Fiberglass-reinforced polymer	–	Trigger safety, Trigger bar safety, Firing pin block
CZ P-10 C	9 × 19, 380 Auto	15	740	187 × 32 × 132	102	Luminescent	No	25±4	9±1	4	Fiberglass-reinforced polymer	–	Trigger safety, Trigger bar safety, Firing pin block
CZ P-10 C OR	9 × 19	15	740	187 × 32 × 135	102	Luminescent	No	25±4	9±1	4	Fiberglass-reinforced polymer	–	Trigger safety, Trigger bar safety, Firing pin block
CZ P-10 C OR FDE	9 × 19	15	740	187 × 32 × 135	102	Luminescent	No	25±4	9±1	4	Fiberglass-reinforced polymer	–	Trigger safety, Trigger bar safety, Firing pin block
CZ P-10 C OR SR	9 × 19	15	760	209 × 32 × 135	122	Luminescent	1/2" × 28 UNEF – 3A	25±4	9±1	4	Fiberglass-reinforced polymer	–	Trigger safety, Trigger bar safety, Firing pin block
CZ P-10 S OR	9 × 19	12	710	170 × 32 × 119	89,5	Luminescent	No	25±4	9±1	4	Fiberglass-reinforced polymer	–	Trigger safety, Trigger bar safety, Firing pin block
CZ P-09 F NOCTURNE	9 × 19	19	830	208 × 37 × 150	115	Luminescent, Tritium	No	SA: 21 DA: 44±2	SA: 10±1 DA: 13±2	7±1	Fiberglass-reinforced polymer	–	Manual safety / decocker, Safety notch on hammer, Firing pin block
CZ P-09 F NOCTURNE SR	9 × 19	19	880	230 × 37 × 150	135	Luminescent, Tritium	1/2" × 28 UNEF – 3A	SA: 21 DA: 44±2	SA: 10±1 DA: 13±2	7±1	Fiberglass-reinforced polymer	–	Manual safety / decocker, Safety notch on hammer, Firing pin block
CZ P-09 C NOCTURNE	9 × 19	15	740	185 × 37 × 137	95	Luminescent, Tritium	No	SA: 21 DA: 44±2	SA: 10±1 DA: 13±2	7±1	Fiberglass-reinforced polymer	–	Manual safety / decocker, Safety notch on hammer, Firing pin block
CZ P-09 C NOCTURNE SR	9 × 19	15	760	207 × 37 × 137	115	Luminescent, Tritium	1/2" × 28 UNEF – 3A	SA: 21 DA: 44±2	SA: 10±1 DA: 13±2	7±1	Fiberglass-reinforced polymer	–	Manual safety / decocker, Safety notch on hammer, Firing pin block
ADAPTERS													
ADAPTER CZ SHADOW 2 KADET	22 LR	10	300		125	Checkered rear sight							
ADAPTER CZ P-09 KADET	22 LR	10	300		120	Checkered rear sight							
ADAPTER CZ P-07 KADET	22 LR	10	280		103	Checkered rear sight							





CENTERFIRE RIFLES

CZ rifles for hunting and sport are traditionally among the best long firearms available on the world market. As with all our products, the CZ brand is synonymous with ingenious design, reliability, accuracy and first-rate quality at an affordable price. The innovative, highly modular design of the CZ 600 series comes with a number of patented features that improve all key characteristics – from reliability and durability to ergonomics and shooting comfort to safety and accuracy.



THE CZ 600 SERIES FEATURES A PATENT PROTECTED BOLT DESIGN THAT ENSURES 100% USER-CONTROLLED FEED IN ALL SHOOTING POSITIONS, AND EVEN UNDER THE MOST DEMANDING CONDITIONS

Other benefits include a patented, ergonomically designed vertical safety with completely silent operation, an exceptional magazine that users can select to function as detachable or locked, an extremely durable finish, and easy disassembly that requires no manipulation of the trigger. Models for hunting, sport and hobby are available in a continuously updated range of popular calibers.

MAIN FEATURES OF THE
CZ 600 SERIES



CONTROLLED FEEDING WITH SHORT EJECTOR
The CZ 600 series combines the best qualities of controlled feed and push feed systems. This simple and reliable patented design delivers 100% user-controlled feed in all shooting positions, and even under the most demanding conditions.



UNIQUE SAFETY
A patented, easy-to-access vertical safety at the top of the grip is released by pressing down and allows for completely silent operation.



LOCKABLE MAGAZINE
A detachable, double-stack magazine with a "push n' click" loading operation contributes to an exceptionally smooth and reliable feeding of rounds. The magazine is easily locked by sliding the magazine release up. When the magazine lock is activated, the firearm changes to a fixed magazine configuration.

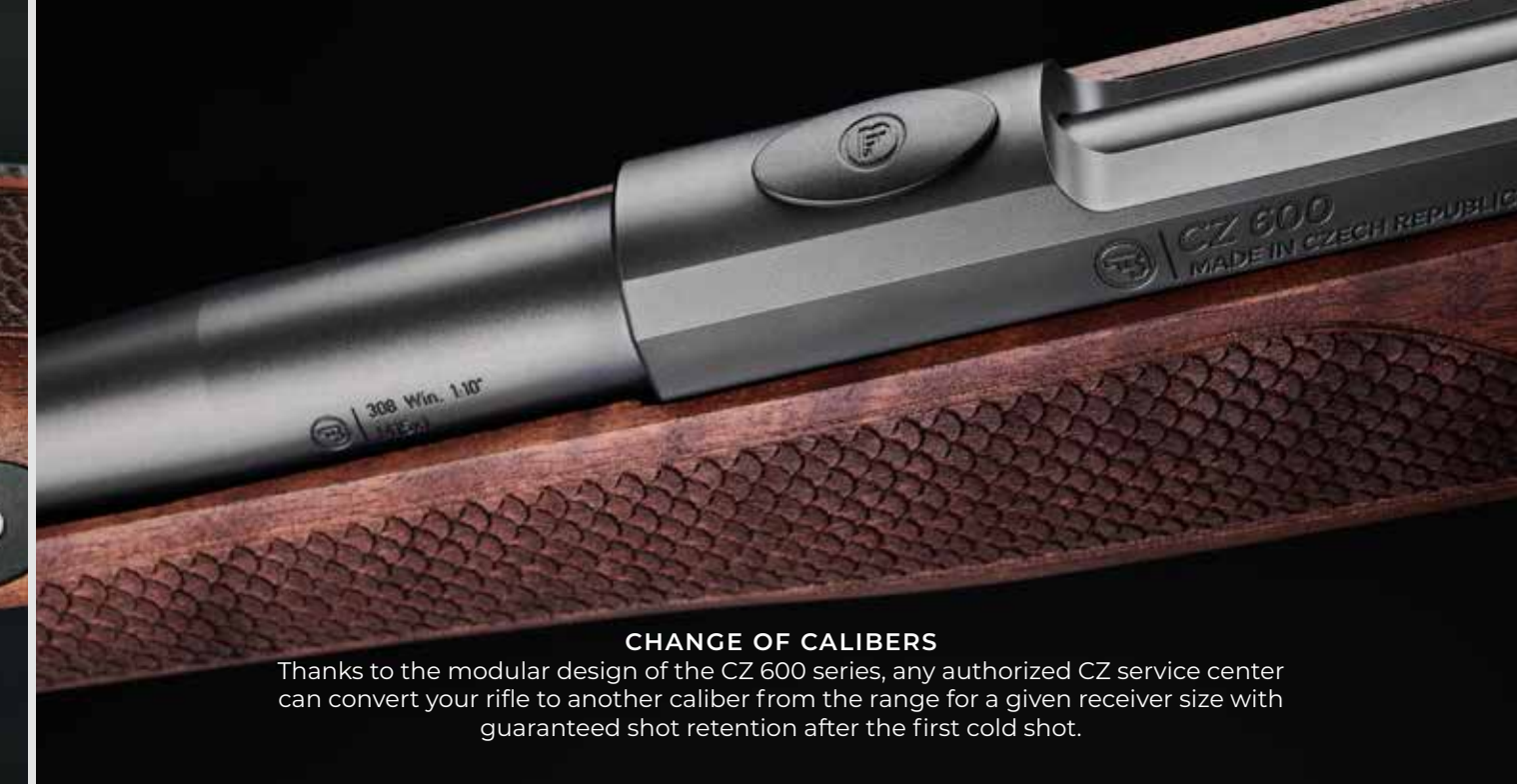

CHANGE OF CALIBERS
Thanks to the modular design of the CZ 600 series, any authorized CZ service center can convert your rifle to another caliber from the range for a given receiver size with guaranteed shot retention after the first cold shot.



SAFE DISASSEMBLY
A spring-loaded button on the right side of the receiver allows for easy removal of the bolt without manipulating the trigger.



EXTREMELY DURABLE FINISH
The surface of metal components in the CZ 600 series comes with CZ's new BobOx chemical heat treatment, which gives it a hard, durable finish that resists corrosion.



PATENTED TRIGGER MECHANISM
A newly developed, user adjustable single- or double-stage trigger mechanism with four levels of pull weight that can be adjusted without removing the receiver from the stock.



EXTREME ACCURACY
The ALPHA, ERGO and LUX models are guaranteed to shoot sub-MOA at 100 m for 3 shot groups, and the RANGE model shoots sub-0.75 MOA for 5 shot groups. The compact TRAIL version is guaranteed to shoot 2 MOA. All models are tested using match-grade factory ammunition.



SHORT ROTATION OF BOLT HANDLE
Due to the use of a locking system, the bolt handle rotates 60° for quick and comfortable reloading without the risk of hitting the riflescope.



SUPERIOR QUALITY BARREL
High-precision barrels with caliber-optimized lengths are cold hammer forged using CZ technology. The barrel features a threaded muzzle for mounting accessories.



STANDARDIZED MOUNTING INTERFACE
CZ 600 series receivers are equipped with an integrated Weaver rail (aluminum) or Remington 700 type mounting interface (steel).



HIGHLY DURABLE RECEIVER
All CZ 600 series receivers are manufactured from durable aluminum or steel and come with a guaranteed service life of 20,000 shots.

NEW CZ 600
AMERICAN



The CZ 600 AMERICAN is an American-style bolt-action centerfire rifle that is equipped with a beautifully crafted Turkish walnut stock with a fleur-de-lis pattern on the grip. Thanks to its straight comb design, the stock allows for comfortable shooting with a riflescope. The steel receiver features a Remington 700-style attachment interface, ensuring compatibility with wide variety of scope rings. Available in a wide range of calibers, from 223 Rem. to 300 Win. Mag., it is ready to meet the needs of a wide range of hunters and sport shooters.



Matthew Emmons

**CHOICE OF
MATTHEW EMMONS (USA)**

**GOLD MEDAL ATHENS 2004
SILVER MEDAL BELJING 2008
BRONZE MEDAL LONDON 2012
PROFESSIONAL SHOOTING COACH
AND AVID HUNTER**

**A MODERN,
AMERICAN-STYLE
CENTERFIRE
HUNTING RIFLE**

MODEL	TWIST RATE / NUMBER OF GROOVES	MAGAZINE CAPACITY	WEIGHT (kg)	LENGTH (mm)	BARREL LENGTH ("/ mm)	BARREL PROFILE	SIGHTS	THREAD	STOCK	FINISH	CHEEKPIECE	LOP (mm)	TRIGGER	TRIGGER PULL WEIGHT (N)	RECEIVER SIZE
CZ 600 AMERICAN 223 Rem.	1:9 / 6	5	3,2	1102	24 / 610	Light	No	M15 x 1	Walnut	Varnish	No	355	Single-Stage, Adjustable	6-13,5	I (mini)
CZ 600 AMERICAN 7,62 x 39	1:9,5 / 4	5	2,8	949	18 / 457	Light	No	M15 x 1	Walnut	Varnish	No	355	Single-Stage, Adjustable	6-13,5	I (mini)
CZ 600 AMERICAN 243 Win.	1:10 / 6	5	3,5	1025	20 / 508	Light	No	M15 x 1	Walnut	Varnish	No	355	Single-Stage, Adjustable	6-13,5	II (medium)
CZ 600 AMERICAN 270 Win.	1:10 / 4	5	3,7	1140	24 / 610	Light	No	M15 x 1	Walnut	Varnish	No	355	Single-Stage, Adjustable	6-13,5	III (long)
CZ 600 AMERICAN 30-06 Spring.	1:10 / 4	5	3,7	1140	24 / 610	Light	No	M15 x 1	Walnut	Varnish	No	355	Single-Stage, Adjustable	6-13,5	III (long)
CZ 600 AMERICAN 300 Win. Mag.	1:10 / 4	3	3,7	1140	24 / 610	Light	No	M15 x 1	Walnut	Varnish	No	355	Single-Stage, Adjustable	6-13,5	III (long)
CZ 600 AMERICAN 308 Win.	1:10 / 4	5	3,5	1025	20 / 508	Light	No	M15 x 1	Walnut	Varnish	No	355	Single-Stage, Adjustable	6-13,5	II (medium)
CZ 600 AMERICAN 6,5 Creedmoor	1:8 / 6	5	3,7	1127	24 / 610	Light	No	M15 x 1	Walnut	Varnish	No	355	Single-Stage, Adjustable	6-13,5	II (medium)

CZ 600 LUX



The newest, centerfire hunting rifle from CZ with a traditional, European-style wood stock is the CZ 600 LUX. Its barrel features mechanical, fiber optic front and rear sights. The steel receiver comes with a Remington 700-type interface for mounting optics.



**A MODERN
CENTERFIRE RIFLE
WITH A TRADITIONAL
EUROPEAN DESIGN**

MODEL	TWIST RATE / NUMBER OF GROOVES	MAGAZINE CAPACITY	WEIGHT (kg)	LENGTH (mm)	BARREL LENGTH (" / mm)	BARREL PROFILE	SIGHTS	THREAD	STOCK	FINISH	CHEEKPIECE	LOP (mm)	TRIGGER	TRIGGER PULL WEIGHT (N)	RECEIVER SIZE
CZ 600 LUX 223 Rem.	1:9/6	5	3,2	997	20/508	Light	Yes	M15 x 1	Walnut	Oil	Yes	370	Single-Stage, Adjustable	6-13,5	I (mini)
NEW CZ 600 LUX 223 Rem. 24"	1:9/6	5	3,4	1099	24/610	Light	Yes	M15 x 1	Walnut	Oil	Yes	370	Single-Stage, Adjustable	6-13,5	I (mini)
NEW CZ 600 LUX 7,62 x 39	1:9,5/4	5	3,0	946	18/457	Light	Yes	M15 x 1	Walnut	Oil	Yes	370	Single-Stage, Adjustable	6-13,5	I (mini)
CZ 600 LUX 308 Win.	1:10/4	5	3,8	1040	20/508	Light	Yes	M15 x 1	Walnut	Oil	Yes	370	Single-Stage, Adjustable	6-13,5	II (medium)
CZ 600 LUX 30-06 Spring.	1:10/4	5	3,7	1053	20/508	Light	Yes	M15 x 1	Walnut	Oil	Yes	370	Single-Stage, Adjustable	6-13,5	III (long)
CZ 600 LUX 8 x 57 IS	1:9,5/4	5	3,6	1053	20/508	Light	Yes	M15 x 1	Walnut	Oil	Yes	370	Single-Stage, Adjustable	6-13,5	III (long)
CZ 600 LUX 300 Win. Mag.	1:10/4	3	3,9	1155	24/610	Light	Yes	M15 x 1	Walnut	Oil	Yes	370	Single-Stage, Adjustable	6-13,5	III (long)

CZ 600 ALPHA



The CZ 600 ALPHA comes with a fiber-reinforced polymer stock and semi-heavy barrel. Optics can be mounted on the Weaver rail integrated on the durable aluminum receiver. Easy maintenance makes this model particularly well suited for those who use their rifle on a daily basis and deeply value durability and reliability, regardless of inclement weather.



**DURABLE
RIFLE
FOR EVERYDAY
USE**

MODEL	TWIST RATE / NUMBER OF GROOVES	MAGAZINE CAPACITY	WEIGHT (kg)	LENGTH (mm)	BARREL LENGTH (" / mm)	BARREL PROFILE	SIGHTS	THREAD	STOCK	FINISH	CHEEKPIECE	LOP (mm)	TRIGGER	TRIGGER PULL WEIGHT (N)	RECEIVER SIZE
CZ 600 ALPHA 223 Rem.	1:7 / 6	5	3,0	1096	24 / 610	Semi-Heavy	No	M15 x 1	Fiber-reinforced polymer	Soft-touch	No	355	Single-Stage, Adjustable	6-13,5	I (mini)
CZ 600 ALPHA 7,62 x 39	1:9,5 / 4	5	2,5	943	18 / 457	Semi-Heavy	No	M15 x 1	Fiber-reinforced polymer	Soft-touch	No	355	Single-Stage, Adjustable	6-13,5	I (mini)
NEW CZ 600 ALPHA 243 Win.	1:10 / 6	5	3,4	1020	20 / 508	Semi-Heavy	No	M15 x 1	Fiber-reinforced polymer	Soft-touch	No	355	Single-Stage, Adjustable	6-13,5	II (medium)
CZ 600 ALPHA 308 Win.	1:10 / 4	5	3,2	1020	20 / 508	Semi-Heavy	No	M15 x 1	Fiber-reinforced polymer	Soft-touch	No	355	Single-Stage, Adjustable	6-13,5	II (medium)
CZ 600 ALPHA 6,5 Creedmoor	1:7 / 6	5	3,4	1071	22 / 559	Semi-Heavy	No	M15 x 1	Fiber-reinforced polymer	Soft-touch	No	355	Single-Stage, Adjustable	6-13,5	II (medium)
CZ 600 ALPHA 6 mm Creedmoor	1:7 / 6	5	3,5	1071	22 / 559	Semi-Heavy	No	M15 x 1	Fiber-reinforced polymer	Soft-touch	No	355	Single-Stage, Adjustable	6-13,5	II (medium)
CZ 600 ALPHA 6,5 PRC	1:7 / 6	3	3,4	1071	24 / 610	Semi-Heavy	No	M15 x 1	Fiber-reinforced polymer	Soft-touch	No	355	Single-Stage, Adjustable	6-13,5	II (medium)
NEW CZ 600 ALPHA 270 Win.	1:10 / 4	5	3,5	1033	20 / 508	Semi-Heavy	No	M15 x 1	Fiber-reinforced polymer	Soft-touch	No	355	Single-Stage, Adjustable	6-13,5	III (long)
CZ 600 ALPHA 30-06 Spring.	1:10 / 4	5	3,3	1033	20 / 508	Semi-Heavy	No	M15 x 1	Fiber-reinforced polymer	Soft-touch	No	355	Single-Stage, Adjustable	6-13,5	III (long)
CZ 600 ALPHA 8 x 57 IS	1:9,5 / 4	5	3,3	1033	20 / 508	Semi-Heavy	No	M15 x 1	Fiber-reinforced polymer	Soft-touch	No	355	Single-Stage, Adjustable	6-13,5	III (long)
CZ 600 ALPHA 300 Win. Mag.	1:10 / 4	3	3,5	1135	24 / 610	Semi-Heavy	No	M15 x 1	Fiber-reinforced polymer	Soft-touch	No	355	Single-Stage, Adjustable	6-13,5	III (long)

CZ 600 ERGO



A model refined for the back-country, the CZ 600 ERGO comes standard with a light profile barrel and an ergonomic, CZ-designed fiber-reinforced polymer stock with a distinctive thumbhole style pistol grip that delivers both comfort and control. All gripping surfaces feature padded inlays. The CZ 600 ERGO has a guaranteed, factory-tested sub-MOA at 100 meters (three-shot groups with match-grade factory ammunition).

MODEL	TWIST RATE / NUMBER OF GROOVES	MAGAZINE CAPACITY	WEIGHT (kg)	LENGTH (mm)	BARREL LENGTH ("/ mm)	BARREL PROFILE	SIGHTS	THREAD	STOCK	FINISH	CHEEKPIECE	LOP (mm)	TRIGGER	TRIGGER PULL WEIGHT (N)	RECEIVER SIZE
CZ 600 ERGO 223 Rem.	1:9 / 6	5	2,6	1013	20 / 508	Light	No	M15 x 1	Fiber-reinforced polymer	Soft-touch	No	370	Single-Stage, Adjustable	6-13,5	I (mini)
NEW CZ 600 ERGO 7,62 x 39	1:9,5 / 4	5	2,4	962	18 / 457	Light	No	M15 x 1	Fiber-reinforced polymer	Soft-touch	No	370	Single-Stage, Adjustable	6-13,5	I (mini)
CZ 600 ERGO 308 Win.	1:10 / 4	5	2,9	1038	20 / 508	Light	No	M15 x 1	Fiber-reinforced polymer	Soft-touch	No	370	Single-Stage, Adjustable	6-13,5	II (medium)
CZ 600 ERGO 6,5 Creedmoor	1:7 / 4	5	3,0	1089	22 / 559	Light	No	M15 x 1	Fiber-reinforced polymer	Soft-touch	No	370	Single-Stage, Adjustable	6-13,5	II (medium)
CZ 600 ERGO 30-06 Spring.	1:10 / 4	5	2,9	1052	20 / 508	Light	No	M15 x 1	Fiber-reinforced polymer	Soft-touch	No	370	Single-Stage, Adjustable	6-13,5	III (long)
CZ 600 ERGO 8 x 57 IS	1:9,5 / 4	5	2,9	1052	20 / 508	Light	No	M15 x 1	Fiber-reinforced polymer	Soft-touch	No	370	Single-Stage, Adjustable	6-13,5	III (long)
CZ 600 ERGO 300 Win. Mag.	1:10 / 4	3	3,1	1154	24 / 610	Light	No	M15 x 1	Fiber-reinforced polymer	Soft-touch	No	370	Single-Stage, Adjustable	6-13,5	III (long)



**CENTERFIRE RIFLE
WITH ERGONOMIC
THUMBHOLE
STOCK**

CZ 600 RANGE



The CZ 600 RANGE is a versatile target and hunting rifle for highly precise shooting at medium to long distances. It comes with a guaranteed, factory-tested accuracy of sub-0.75 MOA at 100 meters (five-shot groups when using match-grade factory ammunition). The stock is optimized for accuracy and features a tool-free, height adjustable comb. This model comes with a nitrided steel receiver with a mounting interface for a Remington 700 type riflescope.

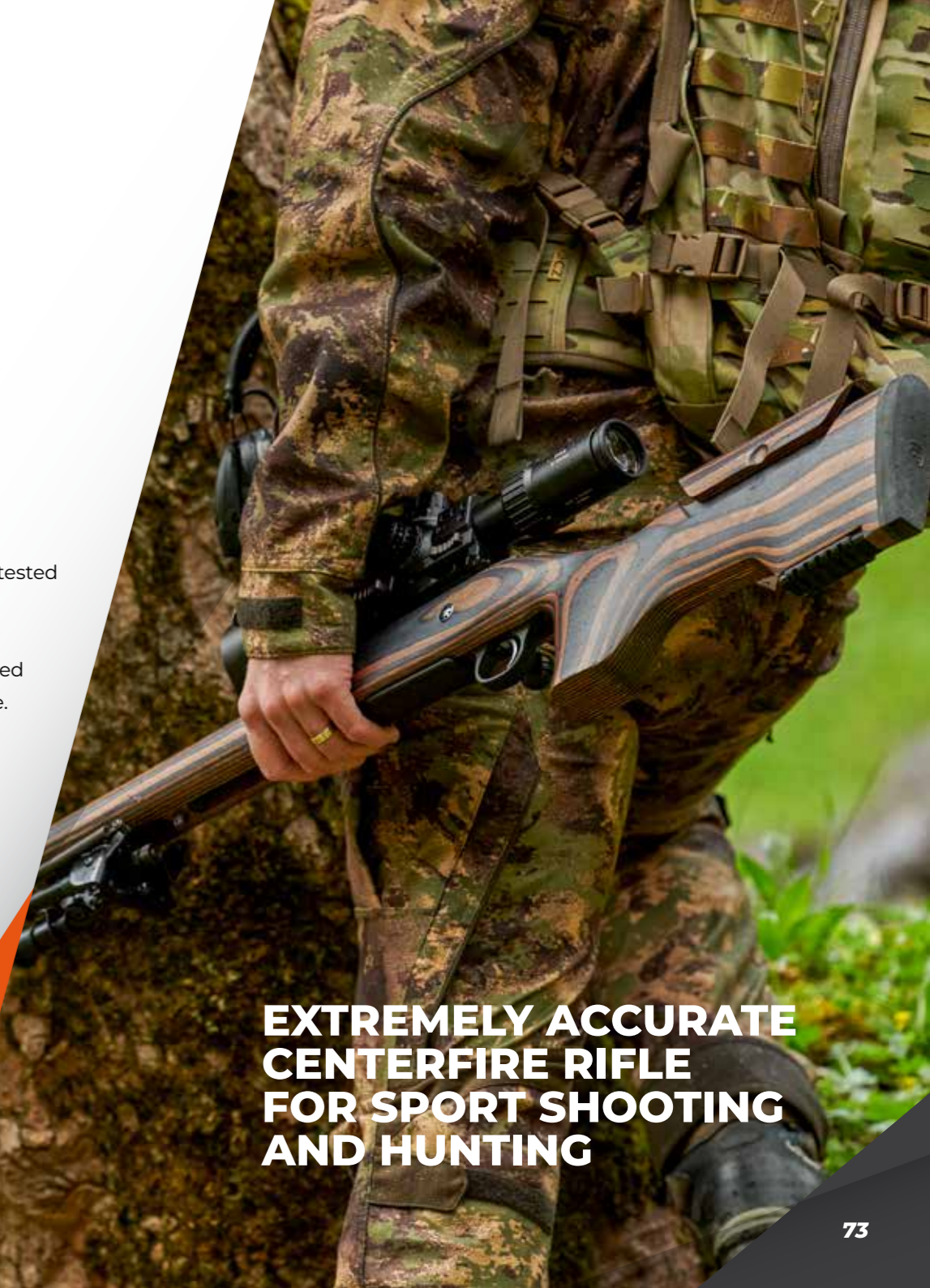

**EXTREMELY ACCURATE
CENTERFIRE RIFLE
FOR SPORT SHOOTING
AND HUNTING**

MODEL	TWIST RATE / NUMBER OF GROOVES	MAGAZINE CAPACITY	WEIGHT (kg)	LENGTH (mm)	BARREL LENGTH ("/ mm)	BARREL PROFILE	SIGHTS	THREAD	STOCK	FINISH	CHEEKPIECE	LOP (mm)	TRIGGER	TRIGGER PULL WEIGHT (N)	RECEIVER SIZE
CZ 600 RANGE 308 Win.	1:10 / 4	5	4,6	1140	24 / 610	Heavy	No	M18 x 1	Laminated Wood	Varnish	Adjustable	370	Single-Stage, Adjustable	6-13,5	II (medium)
CZ 600 RANGE 6 mm Creedmoor	1:7 / 6	5	4,7	1140	24 / 610	Heavy	No	M18 x 1	Laminated Wood	Varnish	Adjustable	370	Single-Stage, Adjustable	6-13,5	II (medium)
NEW CZ 600 RANGE 223 Remington	1:9 / 6	5	4,4	1106	24 / 610	Heavy	Ne	M18 x 1	Laminated Wood	Varnish	Adjustable	365	Single-Stage, Adjustable	6-13,5	I (mini)
NEW CZ 600 RANGE 6,5 Creedmoor	1:8 / 6	5	4,7	1140	24 / 610	Heavy	Ne	M18 x 1	Laminated Wood	Varnish	Adjustable	370	Single-Stage, Adjustable	6-13,5	II (medium)

CZ 600 TRAIL



A compact, accurate, bolt-action rifle with a PDW type telescopic stock and CZ BREN 2 style controls, the CZ 600 TRAIL is available in the popular calibers. It's a perfect choice for hobby shooters who appreciate having a generous amount of Picatinny and M-LOK mounting interfaces.

MODEL	TWIST RATE / NUMBER OF GROOVES	MAGAZINE CAPACITY	WEIGHT (kg)	LENGTH (mm)	BARREL LENGTH (" / mm)	BARREL PROFILE	SIGHTS	THREAD	STOCK	FINISH	CHEEKPIECE	LOP (mm)	TRIGGER	1ST TRIGGER PULL WEIGHT (N)	2ND TRIGGER PULL WEIGHT (N)	RECEIVER SIZE
CZ 600 TRAIL 223 Rem.	1: 7 / 6	10	2,8	690-890	16 / 412	Semi-Heavy	No	M15 x 1	Fiber-reinforced polymer	-	Yes	143-347	Double-Stage, Adjustable	4-6	9,5-17	I (mini)
CZ 600 TRAIL 7,62 x 39	1: 9,5 / 4	10	2,8	690-890	16 / 412	Semi-Heavy	No	M15 x 1	Fiber-reinforced polymer	-	Yes	143-347	Double-Stage, Adjustable	4-6	9,5-17	I (mini)
CZ 600 TRAIL 300 BLK	1: 7 / 4	10	2,8	690-890	16 / 412	Semi-Heavy	No	M15 x 1	Fiber-reinforced polymer	-	Yes	143-347	Double-Stage, Adjustable	4-6	9,5-17	I (mini)



COMPACT SPORTING RIFLE

SPORT SPECIALS THAT COMBINE THE HIGH-END CZ 600 PLATFORM WITH A SOPHISTICATED CHASSIS

from the world-renowned MDT brand. These rifles feature a generous Picatinny rail, M-LOK mounting points, an Arca Swiss rail, ambidextrous controls, an integrated barricade stop, and an AR-15 compatible stock and pistol grip. The steel receiver only allows for use of MDT AICS 10-round magazines equipped with the proprietary CZ follower for fully reliable feeding, even when manually inserting a round into the chamber through the ejection port.

The result is models optimized for the Production Division of the Precision Rifle Series (PRS) and other tactical shooting disciplines. With advanced ergonomics, a heavy profile cold hammer forged barrel, and an innovative single-action, easy-to-adjust trigger mechanism, CZ guarantees sub-0,75 MOA accuracy (five-shot groups at 100 meters using match-grade factory ammunition).



CZ 600 MDT

NEW

CZ 600 MDT GREY

This Light Grey cerakote-finished model features an MDT Elite Pistol Grip, adjustable cheekpiece on an AR-15-style buffer tube, and MDT CCS stock with adjustable LOP via butt pad spacers.



NEW

CZ 600 MDT DEEP BRONZE

The premium Deep Bronze cerakote-finished model features an adjustable MDT Premier Vertical pistol grip, MDT SRS skeleton stock with a fully adjustable cheekpiece (height and axis) and buttstock (height, length, axis), and an effective three-chamber muzzle brake. The extended safety on one side of the firearm also serves as a thumb rest.



MODEL	TWIST RATE / NUMBER OF GROOVES	MAGAZINE CAPACITY	WEIGHT (kg)	LENGTH (mm)	BARREL LENGTH ("/ mm)	BARREL PROFILE	SIGHTS	THREAD	STOCK	FINISH	CHEEKPIECE	LOP (mm)	TRIGGER	TRIGGER PULL WEIGHT (N)	RECEIVER SIZE
CZ 600 MDT GREY 308 Win.	1:10 / 4	10	5,3	1100-1125	24 / 610	Heavy	No	M18 x 1	Duralumin	Cerakote	Yes	330-355	Single-Stage, Adjustable	6-13,5	II (medium)
CZ 600 MDT GREY 6 mm Creedmoor	1:7 / 6	10	5,3	1100-1125	24 / 610	Heavy	No	M18 x 1	Duralumin	Cerakote	Yes	330-355	Single-Stage, Adjustable	6-13,5	II (medium)
CZ 600 MDT GREY 6,5 Creedmoor	1:8 / 6	10	5,3	1100-1125	24 / 610	Heavy	No	M18 x 1	Duralumin	Cerakote	Yes	330-355	Single-Stage, Adjustable	6-13,5	II (medium)
CZ 600 MDT DEEP BRONZE 308 Win.	1:10 / 4	10	5,6	1140-1170	24 / 610	Heavy	No	M18 x 1	Duralumin	Cerakote	Yes	320-350	Single-Stage, Adjustable	6-13,5	II (medium)
CZ 600 MDT DEEP BRONZE 6 mm Creedmoor	1:7 / 6	10	5,6	1140-1170	24 / 610	Heavy	No	M18 x 1	Duralumin	Cerakote	Yes	320-350	Single-Stage, Adjustable	6-13,5	II (medium)
CZ 600 MDT DEEP BRONZE 6,5 Creedmoor	1:8 / 6	10	5,6	1140-1170	24 / 610	Heavy	No	M18 x 1	Duralumin	Cerakote	Yes	320-350	Single-Stage, Adjustable	6-13,5	II (medium)

BUILT TO DOMINATE THE PRS PRODUCTION DIVISION

NEW CZ 600+
**ERGO
DRIVEN HUNT**



Feedback from customers, along with experience gained in production of the CZ 600, was then put to good use for the improved CZ 600+ model. The first flagship in this series is the CZ 600+ ERGO DRIVEN HUNT model. A user replaceable barrel, new magazine, and extended weaver rail are just a few of the improvements that come as standard on the new CZ 600+ ERGO DRIVEN HUNT. Let's take a closer look.

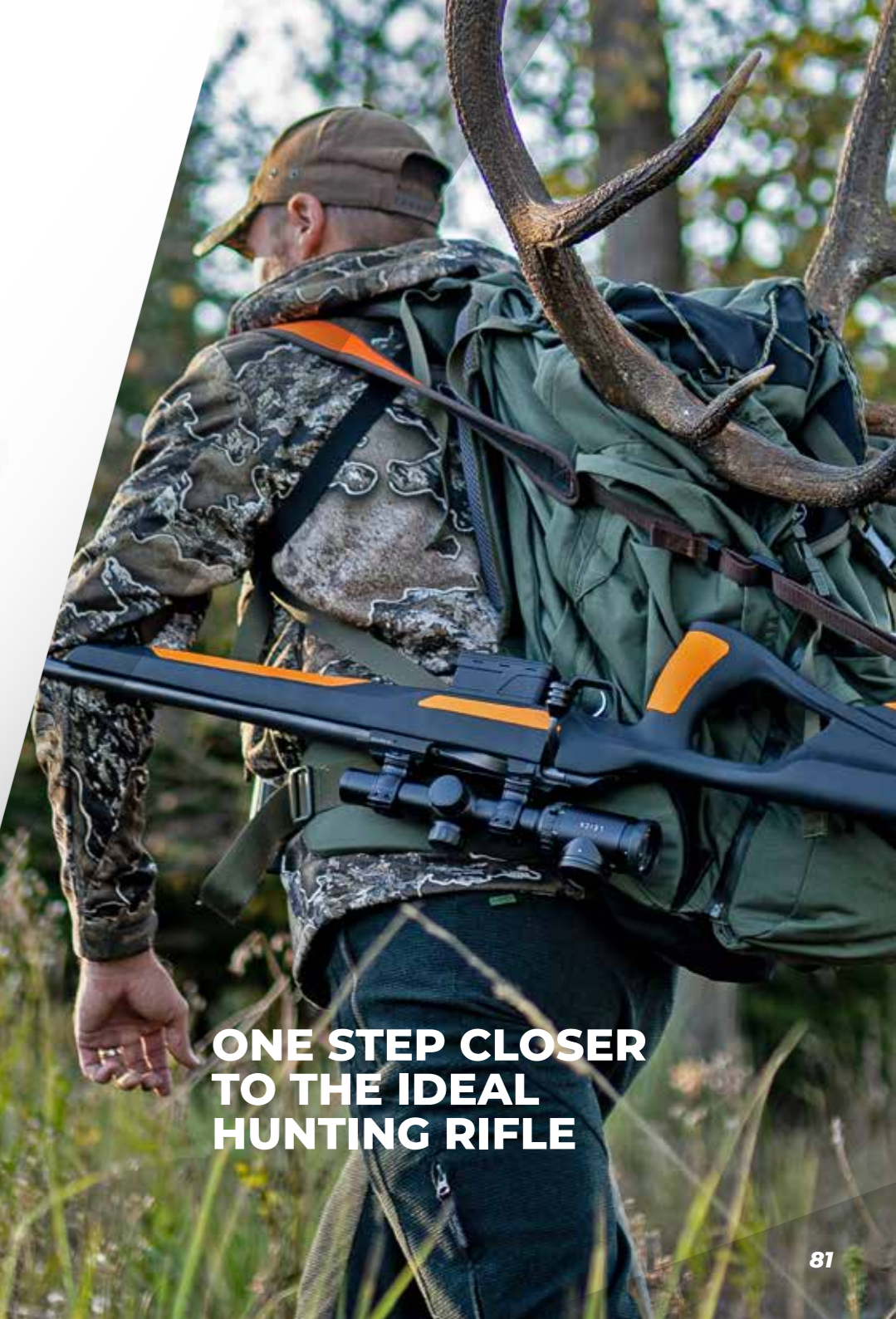

**ONE STEP CLOSER
TO THE IDEAL
HUNTING RIFLE**

MODEL	TWIST RATE / NUMBER OF GROOVES	MAGAZINE CAPACITY	WEIGHT (kg)	LENGTH (mm)	BARREL LENGTH ("/ mm)	BARREL PROFILE	SIGHTS	THREAD	STOCK	FINISH	CHEEKPIECE	LOP (mm)	TRIGGER	TRIGGER PULL WEIGHT (N)	RECEIVER SIZE
NEW CZ 600+ ERGO DRIVEN HUNT 308 Win.	1:10 / 4	10	2,9	1038	20 / 508	Light	No	M15 x 1	Polymer	Soft-touch	No	370	Single-Stage, Adjustable	6-13,5	II (medium)



C0300-0001
CZ 600 MIL-STD-1913 RAIL
MEDIUM 0 MOA

6000-3320-02ND
CZ 600 BOLT HANDLE,
WOOD KNOB

1070-7011
SPUHR SCOPE MOUNT 2PCS
HP 30-25 Ø 30 H25, 4 MM



C0302-0002
LEICA FORTIS RIFLESCOPE
6.2.5-15 × 56l (L-4A)

6003-4000-6401ND
CZ 600 MAG 223 REM.,
5 ROUND

6003-4000-7301ND
CZ 600 MAG 7,62 × 39, 5 ROUND

C0315-0000
CZ GAMEHAMMER
RIFLE SLING, BLACK

**RECOMMENDED
ACCESSORIES**



6000-3322-01ND
CZ 600 BOLT HANDLE,
POLYMER KNOB

C0302-0001
LEICA MAGNUS RIFLESCOPE
1-6.3 × 24 l (L-3D)

1070-7011
SPUHR SCOPE MOUNT 2PCS
HP 30-25 Ø 30 H25, 4 MM



C0307-0027M
SILENCER A-TEC OPTIMA
50 ≤30 15×1

6003-4500-5301ND
CZ 600 MAG 308 WIN., 6 MM
CREEDMOOR, 6,5 CREEDMOOR,
243 WIN. - 10 ROUND /
6,5 PRC - 6 ROUND

1002-4100-05
ATI SLING SWIVEL

C0315-0002
CZ SAUENHAMMER
RIFLE SLING, ORANGE



C0302-0001
LEICA MAGNUS RIFLESCOPE
1-6.3 × 24 I (L-3D)

1070-7011
SPUHR SCOPE MOUNT
2PCS HP 30-25 Ø 30 H25, 4 MM

6003-4000-5301ND
CZ 600 MAG 308 WIN.,
6 MM CREEDMOOR,
6,5 CREEDMOOR, 243 WIN.
- 5 ROUND /
6,5 PRC - 3 ROUND

1081-7383
TRIGATTI RIFLE SLING
(2 PCS IN PACKAGE)

C0315-0000
CZ GAMEHAMMER
RIFLE SLING, BLACK

**RECOMMENDED
ACCESSORIES**

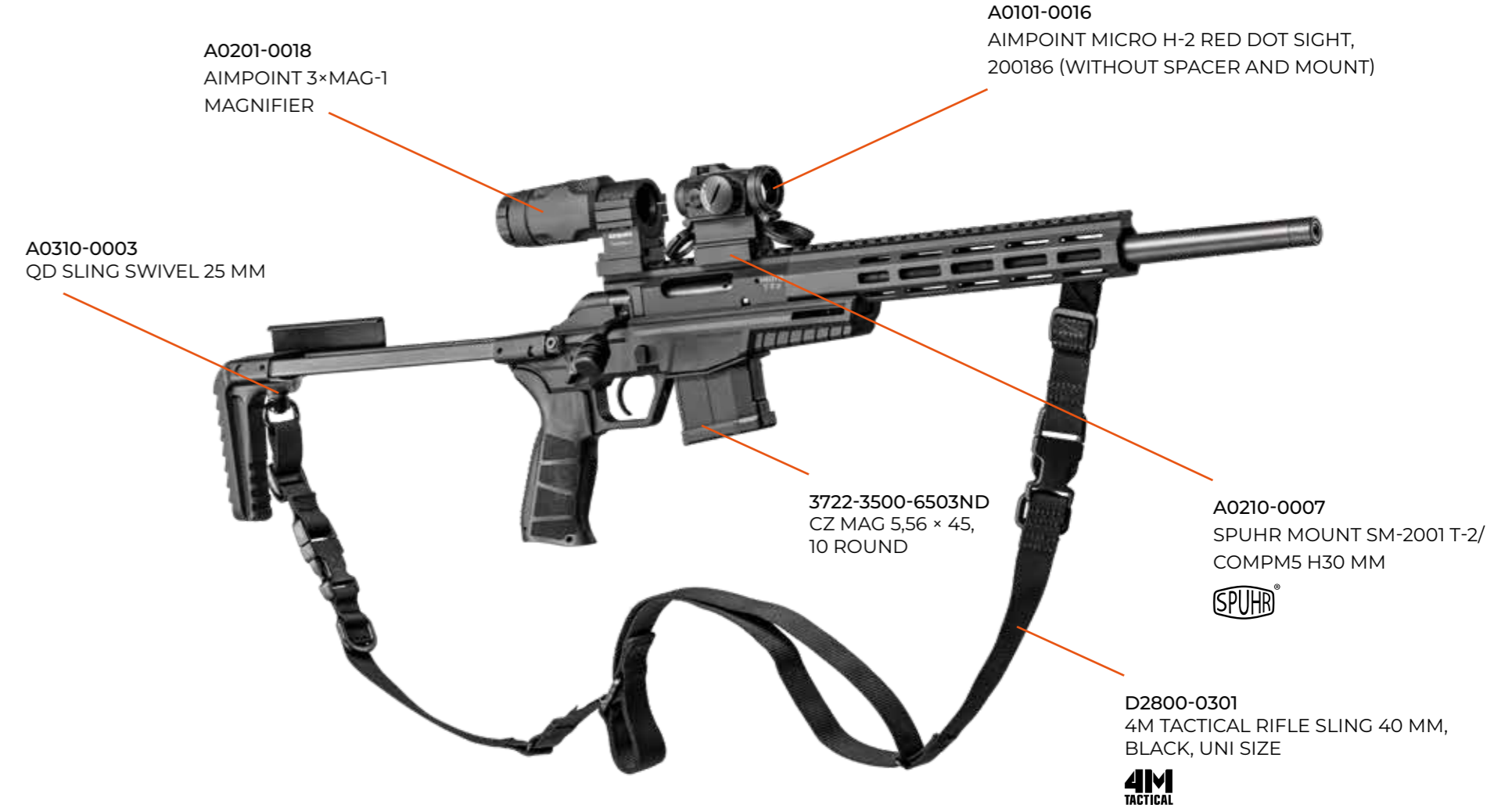



A0201-0018
AIMPOINT 3×MAG-1
MAGNIFIER

A0101-0016
AIMPOINT MICRO H-2 RED DOT SIGHT,
200186 (WITHOUT SPACER AND MOUNT)

A0310-0003
QD SLING SWIVEL 25 MM

3722-3500-6503ND
CZ MAG 5,56 × 45,
10 ROUND

A0210-0007
SPUHR MOUNT SM-2001 T-2/
COMP5 H30 MM

D2800-0301
4M TACTICAL RIFLE SLING 40 MM,
BLACK, UNI SIZE

CENTERFIRE RIFLES

CENTERFIRE RIFLES PARAMETERS

MODEL	TWIST RATE / NUMBER OF GROOVES	MAGAZINE CAPACITY	WEIGHT (kg)	LENGTH (mm)	BARREL LENGTH ("/ mm)	BARREL PROFILE	SIGHTS	THREAD	STOCK	FINISH	CHEEKPIECE	LOP (mm)	TRIGGER	TRIGGER PULL WEIGHT (N)	RECEIVER SIZE
CZ 600 AMERICAN 223 Rem.	1:9/6	5	3,2	1102	24/610	Light	No	M15 x 1	Walnut	Varnish	No	355	Single-Stage, Adjustable	6-13,5	I (mini)
CZ 600 AMERICAN 7,62 x 39	1:9,5/4	5	2,8	949	18/457	Light	No	M15 x 1	Walnut	Varnish	No	355	Single-Stage, Adjustable	6-13,5	I (mini)
CZ 600 AMERICAN 243 Win.	1:10/6	5	3,5	1025	20/508	Light	No	M15 x 1	Walnut	Varnish	No	355	Single-Stage, Adjustable	6-13,5	II (medium)
CZ 600 AMERICAN 270 Win.	1:10/4	5	3,7	1140	24/610	Light	No	M15 x 1	Walnut	Varnish	No	355	Single-Stage, Adjustable	6-13,5	III (long)
CZ 600 AMERICAN 30-06 Spring.	1:10/4	5	3,7	1140	24/610	Light	No	M15 x 1	Walnut	Varnish	No	355	Single-Stage, Adjustable	6-13,5	III (long)
CZ 600 AMERICAN 300 Win. Mag.	1:10/4	3	3,7	1140	24/610	Light	No	M15 x 1	Walnut	Varnish	No	355	Single-Stage, Adjustable	6-13,5	III (long)
CZ 600 AMERICAN 308 Win.	1:10/4	5	3,5	1025	20/508	Light	No	M15 x 1	Walnut	Varnish	No	355	Single-Stage, Adjustable	6-13,5	II (medium)
CZ 600 AMERICAN 6,5 Creedmoor	1:8/6	5	3,7	1127	24/610	Light	No	M15 x 1	Walnut	Varnish	No	355	Single-Stage, Adjustable	6-13,5	II (medium)
CZ 600 LUX 223 Rem.	1:9/6	5	3,2	997	20/508	Light	Yes	M15 x 1	Walnut	Oil	Yes	370	Single-Stage, Adjustable	6-13,5	I (mini)
CZ 600 LUX 223 Rem. 24"	1:9/6	5	3,4	1099	24/610	Light	Yes	M15 x 1	Walnut	Oil	Yes	370	Single-Stage, Adjustable	6-13,5	I (mini)
NEW CZ 600 LUX 7,62 x 39	1:9,5/4	5	3,0	946	18/457	Light	Yes	M15 x 1	Walnut	Oil	Yes	370	Single-Stage, Adjustable	6-13,5	I (mini)
CZ 600 LUX 308 Win.	1:10/4	5	3,8	1040	20/508	Light	Yes	M15 x 1	Walnut	Oil	Yes	370	Single-Stage, Adjustable	6-13,5	II (medium)
CZ 600 LUX 30-06 Spring.	1:10/4	5	3,7	1053	20/508	Light	Yes	M15 x 1	Walnut	Oil	Yes	370	Single-Stage, Adjustable	6-13,5	III (long)
CZ 600 LUX 8 x 57 IS	1:9,5/4	5	3,6	1053	20/508	Light	Yes	M15 x 1	Walnut	Oil	Yes	370	Single-Stage, Adjustable	6-13,5	III (long)
CZ 600 LUX 300 Win. Mag.	1:10/4	3	3,9	1155	24/610	Light	Yes	M15 x 1	Walnut	Oil	Yes	370	Single-Stage, Adjustable	6-13,5	III (long)
CZ 600 ALPHA 223 Rem.	1:7/6	5	3,0	1096	24/610	Semi-Heavy	No	M15 x 1	Fiber-reinforced polymer	Soft-touch	No	355	Single-Stage, Adjustable	6-13,5	I (mini)
CZ 600 ALPHA 7,62 x 39	1:9,5/4	5	2,5	943	18/457	Semi-Heavy	No	M15 x 1	Fiber-reinforced polymer	Soft-touch	No	355	Single-Stage, Adjustable	6-13,5	I (mini)
NEW CZ 600 ALPHA 243 Win.	1:10/6	5	3,4	1020	20/508	Semi-Heavy	No	M15 x 1	Fiber-reinforced polymer	Soft-touch	No	355	Single-Stage, Adjustable	6-13,5	II (medium)
CZ 600 ALPHA 308 Win.	1:10/4	5	3,2	1020	20/508	Semi-Heavy	No	M15 x 1	Fiber-reinforced polymer	Soft-touch	No	355	Single-Stage, Adjustable	6-13,5	II (medium)
CZ 600 ALPHA 6,5 Creedmoor	1:7/6	5	3,4	1071	22/559	Semi-Heavy	No	M15 x 1	Fiber-reinforced polymer	Soft-touch	No	355	Single-Stage, Adjustable	6-13,5	II (medium)
CZ 600 ALPHA 6 mm Creedmoor	1:7/6	5	3,5	1071	22/559	Semi-Heavy	No	M15 x 1	Fiber-reinforced polymer	Soft-touch	No	355	Single-Stage, Adjustable	6-13,5	II (medium)
CZ 600 ALPHA 6,5 PRC	1:7/6	3	3,4	1071	24/610	Semi-Heavy	No	M15 x 1	Fiber-reinforced polymer	Soft-touch	No	355	Single-Stage, Adjustable	6-13,5	II (medium)
NEW CZ 600 ALPHA 270 Win.	1:10/4	5	3,5	1033	20/508	Semi-Heavy	No	M15 x 1	Fiber-reinforced polymer	Soft-touch	No	355	Single-Stage, Adjustable	6-13,5	III (long)
CZ 600 ALPHA 30-06 Spring.	1:10/4	5	3,3	1033	20/508	Semi-Heavy	No	M15 x 1	Fiber-reinforced polymer	Soft-touch	No	355	Single-Stage, Adjustable	6-13,5	III (long)
CZ 600 ALPHA 8 x 57 IS	1:9,5/4	5	3,3	1033	20/508	Semi-Heavy	No	M15 x 1	Fiber-reinforced polymer	Soft-touch	No	355	Single-Stage, Adjustable	6-13,5	III (long)
CZ 600 ALPHA 300 Win. Mag.	1:10/4	3	3,5	1135	24/610	Semi-Heavy	No	M15 x 1	Fiber-reinforced polymer	Soft-touch	No	355	Single-Stage, Adjustable	6-13,5	III (long)



CENTERFIRE RIFLES

CENTERFIRE RIFLES PARAMETERS

MODEL	TWIST RATE / NUMBER OF GROOVES	MAGAZINE CAPACITY	WEIGHT (kg)	LENGTH (mm)	BARREL LENGTH ("/ mm)	BARREL PROFILE	SIGHTS	THREAD	STOCK	FINISH	CHEEKPIECE	LOP (mm)	TRIGGER	TRIGGER PULL WEIGHT (N)	RECEIVER SIZE
CZ 600 ERGO 223 Rem.	1:9/6	5	2,6	1013	20/508	Light	No	M15 x 1	Fiber-reinforced polymer	Soft-touch	No	370	Single-Stage, Adjustable	6-13,5	I (mini)
NEW CZ 600 ERGO 7,62 x 39	1:9,5/4	5	2,4	962	18/457	Light	No	M15 x 1	Fiber-reinforced polymer	Soft-touch	No	370	Single-Stage, Adjustable	6-13,5	I (mini)
CZ 600 ERGO 308 Win.	1:10/4	5	2,9	1038	20/508	Light	No	M15 x 1	Fiber-reinforced polymer	Soft-touch	No	370	Single-Stage, Adjustable	6-13,5	II (medium)
CZ 600 ERGO 6,5 Creedmoor	1:7/4	5	3,0	1089	22/559	Light	No	M15 x 1	Fiber-reinforced polymer	Soft-touch	No	370	Single-Stage, Adjustable	6-13,5	II (medium)
CZ 600 ERGO 30-06 Spring.	1:10/4	5	2,9	1052	20/508	Light	No	M15 x 1	Fiber-reinforced polymer	Soft-touch	No	370	Single-Stage, Adjustable	6-13,5	III (long)
CZ 600 ERGO 8 x 57 IS	1:9,5/4	5	2,9	1052	20/508	Light	No	M15 x 1	Fiber-reinforced polymer	Soft-touch	No	370	Single-Stage, Adjustable	6-13,5	III (long)
CZ 600 ERGO 300 Win. Mag.	1:10/4	3	3,1	1154	24/610	Light	No	M15 x 1	Fiber-reinforced polymer	Soft-touch	No	370	Single-Stage, Adjustable	6-13,5	III (long)
CZ 600 RANGE 308 Win.	1:10/4	5	4,6	1140	24/610	Heavy	No	M18 x 1	Laminated Wood	Varnish	Adjustable	370	Single-Stage, Adjustable	6-13,5	II (medium)
CZ 600 RANGE 6 mm Creedmoor	1:7/6	5	4,7	1140	24/610	Heavy	No	M18 x 1	Laminated Wood	Varnish	Adjustable	370	Single-Stage, Adjustable	6-13,5	II (medium)
NEW CZ 600 RANGE 223 Remington	1:9/6	5	4,4	1106	24/610	Heavy	Ne	M18 x 1	Laminated Wood	Varnish	Adjustable	365	Single-Stage, Adjustable	6-13,5	I (mini)
NEW CZ 600 RANGE 6,5 Creedmoor	1:8/6	5	4,7	1140	24/610	Heavy	Ne	M18 x 1	Laminated Wood	Varnish	Adjustable	370	Single-Stage, Adjustable	6-13,5	II (medium)

MODEL	TWIST RATE / NUMBER OF GROOVES	MAGAZINE CAPACITY	WEIGHT (kg)	LENGTH (mm)	BARREL LENGTH ("/ mm)	BARREL PROFILE	SIGHTS	THREAD	STOCK	FINISH	CHEEKPIECE	LOP (mm)	TRIGGER	1ST TRIGGER PULL WEIGHT (N)	2ND TRIGGER PULL WEIGHT (N)	RECEIVER SIZE
CZ 600 TRAIL 223 Rem.	1:7/6	10	2,8	690-890	16/412	Semi-Heavy	No	M15 x 1	Fiber-reinforced polymer	-	Yes	143-347	Double-Stage, Adjustable	4-6	9,5-17	I (mini)
CZ 600 TRAIL 7,62 x 39	1:9,5/4	10	2,8	690-890	16/412	Semi-Heavy	No	M15 x 1	Fiber-reinforced polymer	-	Yes	143-347	Double-Stage, Adjustable	4-6	9,5-17	I (mini)
CZ 600 TRAIL 300 BLK	1:7/4	10	2,8	690-890	16/412	Semi-Heavy	No	M15 x 1	Fiber-reinforced polymer	-	Yes	143-347	Double-Stage, Adjustable	4-6	9,5-17	I (mini)

MODEL	TWIST RATE / NUMBER OF GROOVES	MAGAZINE CAPACITY	WEIGHT (kg)	LENGTH (mm)	BARREL LENGTH ("/ mm)	BARREL PROFILE	SIGHTS	THREAD	STOCK	FINISH	CHEEKPIECE	LOP (mm)	TRIGGER	TRIGGER PULL WEIGHT (N)	RECEIVER SIZE
CZ 600 MDT GREY 308 Win.	1:10/4	10	5,3	1100-1125	24/610	Heavy	No	M18 x 1	Duralumin	Cerakote	Yes	330-355	Single-Stage, Adjustable	6-13,5	II (medium)
CZ 600 MDT GREY 6 mm Creedmoor	1:7/6	10	5,3	1100-1125	24/610	Heavy	No	M18 x 1	Duralumin	Cerakote	Yes	330-355	Single-Stage, Adjustable	6-13,5	II (medium)
CZ 600 MDT GREY 6,5 Creedmoor	1:8/6	10	5,3	1100-1125	24/610	Heavy	No	M18 x 1	Duralumin	Cerakote	Yes	330-355	Single-Stage, Adjustable	6-13,5	II (medium)
CZ 600 MDT DEEP BRONZE 308 Win.	1:10/4	10	5,6	1140-1170	24/610	Heavy	No	M18 x 1	Duralumin	Cerakote	Yes	320-350	Single-Stage, Adjustable	6-13,5	II (medium)
CZ 600 MDT DEEP BRONZE 6 mm Creedmoor	1:7/6	10	5,6	1140-1170	24/610	Heavy	No	M18 x 1	Duralumin	Cerakote	Yes	320-350	Single-Stage, Adjustable	6-13,5	II (medium)
CZ 600 MDT DEEP BRONZE 6,5 Creedmoor	1:8/6	10	5,6	1140-1170	24/610	Heavy	No	M18 x 1	Duralumin	Cerakote	Yes	320-350	Single-Stage, Adjustable	6-13,5	II (medium)

MODEL	TWIST RATE / NUMBER OF GROOVES	MAGAZINE CAPACITY	WEIGHT (kg)	LENGTH (mm)	BARREL LENGTH ("/ mm)	BARREL PROFILE	SIGHTS	THREAD	STOCK	FINISH	CHEEKPIECE	LOP (mm)	TRIGGER	TRIGGER PULL WEIGHT (N)	RECEIVER SIZE
NEW CZ 600+ ERGO DRIVEN HUNT 308 Win.	1:10/4	10	2,9	1038	20/508	Light	No	M15 x 1	Polymer	Soft-touch	No	370	Single-Stage, Adjustable	6-13,5	II (medium)





RIMFIRE RIFLES

A gateway to the fascinating world of guns and shooting. They're an irreplaceable training aid and exciting source of entertainment, as well as an effective hunting tool and target shooter. These are considered the traditional qualities of long firearms that use rimfire ammunition, so-called rimfire rifles, and models from CZ have been designed by leading experts with a focus on innovation, shooting comfort, safety and advantageous pricing. The best proof of their success is the millions of satisfied customers and fans around the world, together with the fact that CZ is considered a global standard in this segment. The backbone of its current range is the CZ 457 bolt-action rifle series, which brings many outstanding features to the table.



CZ 457 SERIES A NEW GENERATION OF MODERN RIMFIRE RIFLES

The CZ 457 series offers exceptional user comfort due to its easy, fast and reliable operation, even with a mounted riflescope. For maximum safety, it comes with a push-to-fire safety on the right side of the receiver, striker status indicator and a separate bolt extractor control. Shooting accuracy is ensured with its adjustable trigger mechanism that features low trigger pull weight and excellent travel, combined with a noticeably lighter striker and a new type of bedding. Other benefits include an extremely durable anticorrosion finish on metal parts, easy change of caliber by users and reliable polymer magazines that are compatible with the previous generation of CZ rimfire rifles.

MAIN FEATURES OF THE
CZ 457 SERIES



Adjustable trigger mechanism for setting pull weight and trigger travel



Striker status indicator



Top quality cold hammer forged barrels and easy replacement of barrel with an option to change the caliber



New ergonomic stocks

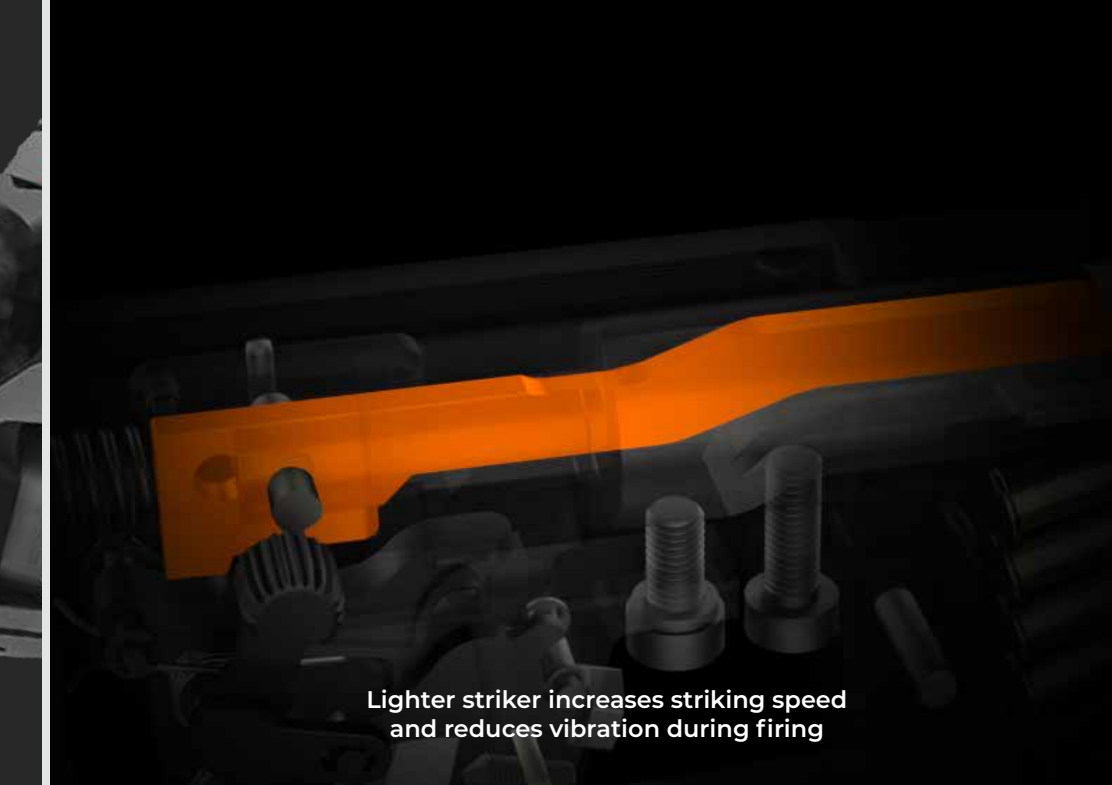

Lighter striker increases striking speed and reduces vibration during firing

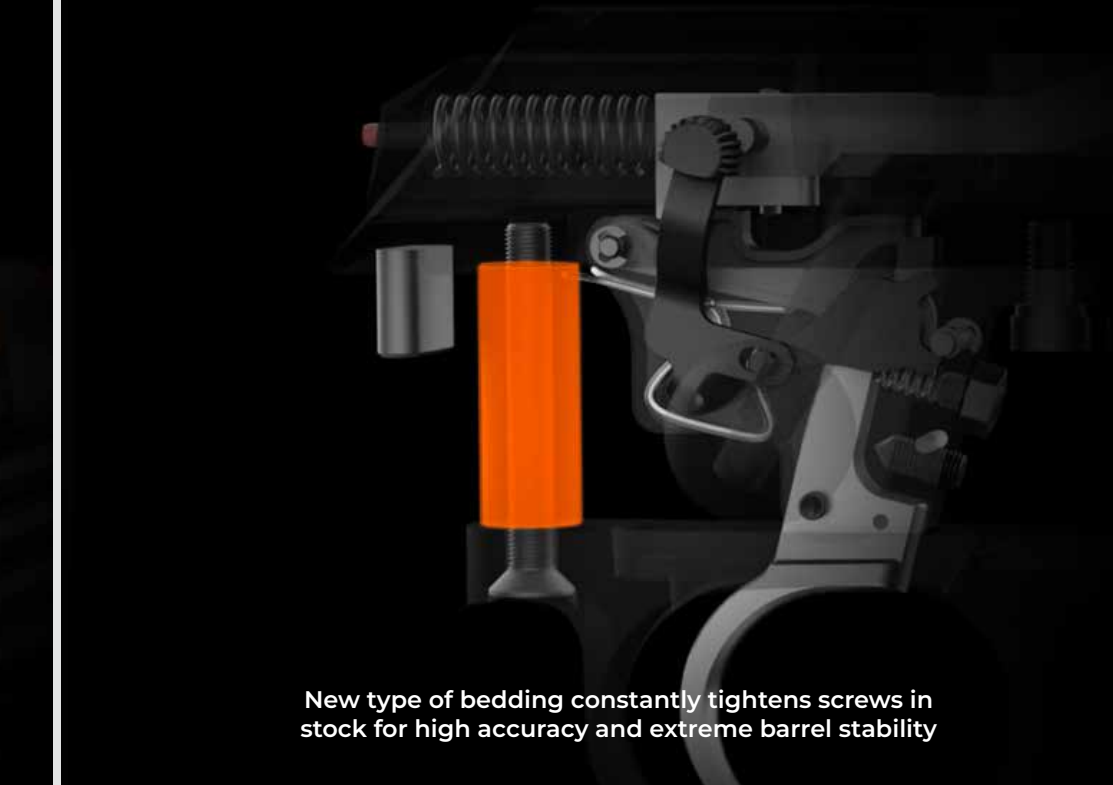

New type of bedding constantly tightens screws in stock for high accuracy and extreme barrel stability

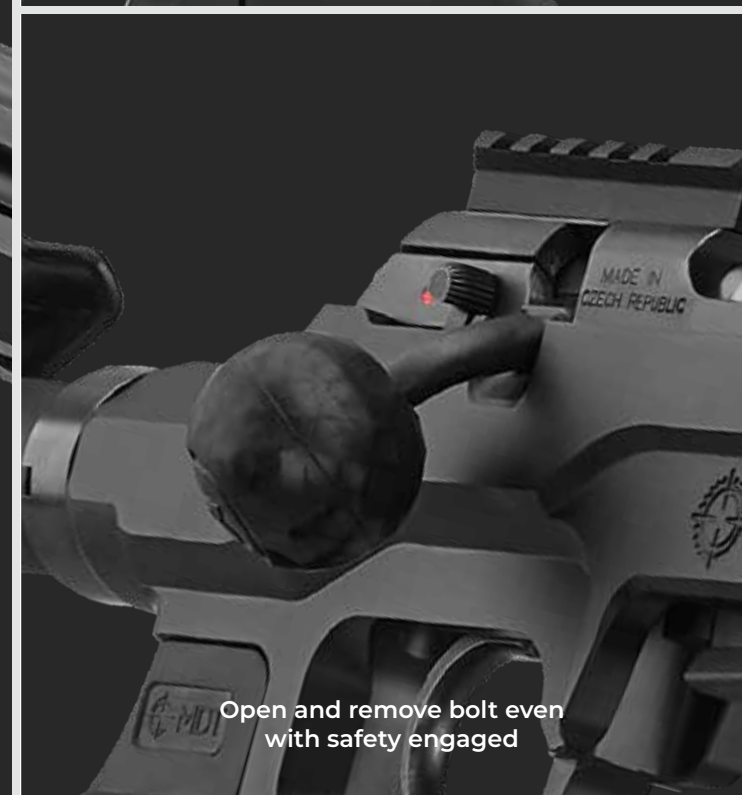

Open and remove bolt even with safety engaged



Intuitive push-to-fire safety



Separate bolt removal

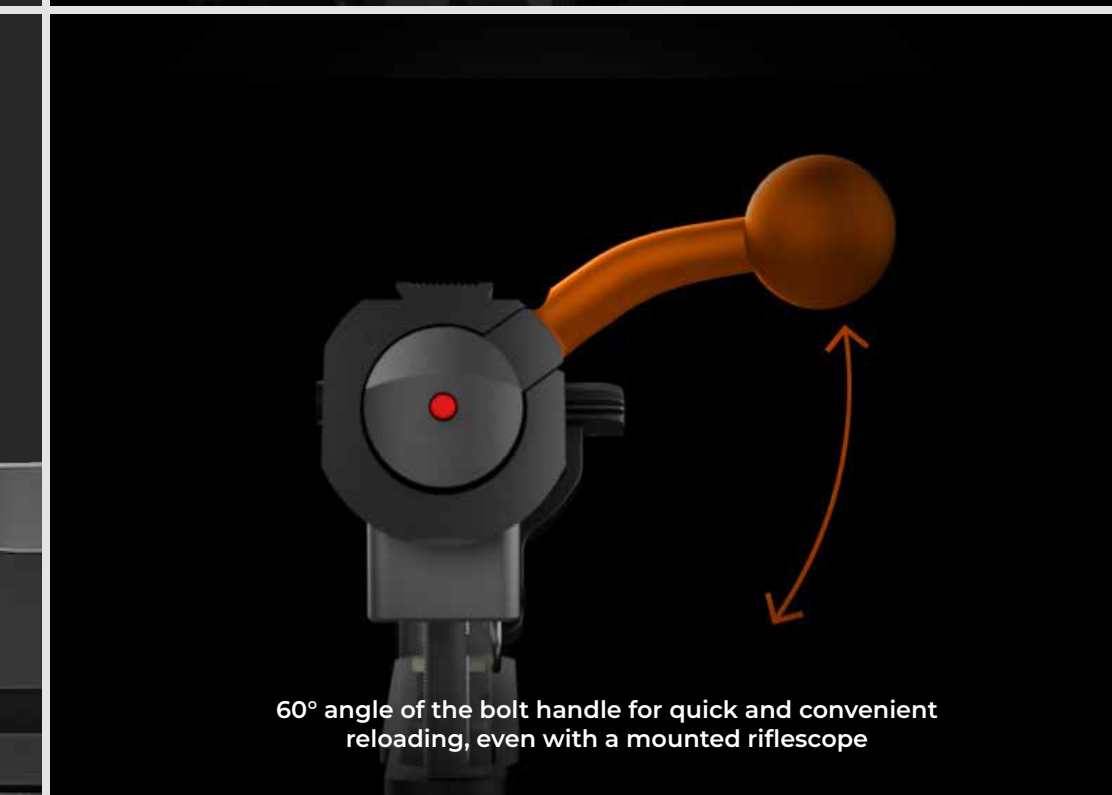

60° angle of the bolt handle for quick and convenient reloading, even with a mounted riflescope



Match chamber (selected 22 LR caliber models)

NEW**CZ 457
ERGO**

The CZ 457 ERGO is built on the popular and time-proven modular CZ 457 platform, enhanced with a new thumbhole-style stock inspired by the design of the CZ 600 Ergo. This polymer stock, reinforced with fiberglass and equipped with a removable cheekpiece, offers excellent comfort and high durability while maintaining a very pleasant weight.



The CZ 457 ERGO is fitted with a cold hammer-forged barrel measuring 525 mm in length, featuring a standardized thread for mounting muzzle devices. It is available in a version with iron sights or a variant without sights, ideal for mounting a riflescope. For the version with iron sights, mounting holes can be covered with included plugs after the sights are removed.



MODEL	CALIBER (TWIST RATE) / NUMBER OF GROOVES	MAGAZINE CAPACITY	WEIGHT (kg)	LENGTH (mm)	BARREL LENGTH (" / mm)	BARREL PROFILE	SIGHTS	THREAD	COMPENSATOR	STOCK	FINISH	CHEEKPIECE	LOP (mm)	TRIGGER	TRIGGER PULL WEIGHT (N)
CZ 457 ERGO with sights	22 LR (1 : 16) / 6	5	2,3	976	20 / 525	Light	Yes	1/2 × 20	No	Polymer	–	Detachable	365	Adjustable	11,1–14
CZ 457 ERGO BM without sights	22 LR (1 : 16) / 6	5	2,3	976	20 / 525	Light	No	1/2 × 20	No	Polymer	–	Detachable	365	Adjustable	11,1–14

NEW**CZ 457****CARBON**

The new, key feature of the CZ 457 CARBON, chambered in 22 LR, is an innovative composite barrel that combines the best properties of steel and carbon fiber to provide many unique advantages. Due to this advanced technology, the CZ 457 CARBON weighs in at only 2.15 kg, making it the lightest model in the CZ 457 series. It delivers the accuracy of varmint models, together with a host of new benefits.



**EXTREMELY
LIGHTWEIGHT
RIMFIRE RIFLE**

MODEL	CALIBER (TWIST RATE) / NUMBER OF GROOVES	MAGAZINE CAPACITY	WEIGHT (kg)	LENGTH (mm)	BARREL LENGTH (" / mm)	BARREL PROFILE	SIGHTS	THREAD	COMPENSATOR	STOCK	FINISH	CHEEKPIECE	LOP (mm)	TRIGGER	TRIGGER PULL WEIGHT (N)
CZ 457 CARBON	22 LR (1 : 16) / 6	5	2,2	977	20 / 525	Carbon fiber-wrapped steel	No	1/2 x 20 UNF	No	Polymer	Soft-touch	No	356	Adjustable	11,1-14

NEW**CZ 457
RANGE**

A new sport and hunting rimfire rifle based on the design of the CZ 600 RANGE centerfire rifle. This 22 LR model, like its large-caliber brother, is a versatile firearm for high-precision shooting at medium to long distances. It is an ideal choice for static and dynamic target shooting, as well as for hunting small game and varmints.

High accuracy is achieved thanks to its heavy, 525 or 610 mm (20" or 24") cold hammer forged barrel with MATCH chamber. The muzzle with thread protector comes with standardized threading for easy mounting of accessories.

Its laminated and varnished adjustable wood stock makes a significant contribution to both accuracy and comfort.



MODEL	CALIBER (TWIST RATE) / NUMBER OF GROOVES	MAGAZINE CAPACITY	WEIGHT (kg)	LENGTH (mm)	BARREL LENGTH (" / mm)	BARREL PROFILE	SIGHTS	THREAD	COMPENSATOR	STOCK	FINISH	CHEEKPIECE	LOP (mm)	TRIGGER	TRIGGER PULL WEIGHT (N)
CZ 457 RANGE 20"	22 LR (1:16) / 6	5	3,7	980	20 / 525	Varmint Match	No	1/2 × 20	No	Laminated Wood	Varnish	Adjustable	365	Adjustable	11,1-14
CZ 457 RANGE 24"	22 LR (1:16) / 6	5	4	990	24 / 630	Varmint Match	No	1/2 × 20	No	Laminated Wood	Varnish	Adjustable	365	Adjustable	11,1-14



CZ 457 MDT

An innovative sport model with a visually appealing duralumin chassis from the renowned MDT brand. Its fluted barrel with MATCH chamber is fitted with a compensator and the stock, optimized for extreme shooting comfort, features a height adjustable comb. LOP can be changed through the use of the four included buttpad spacers. The Picatinny mounting rail with 25 MOA inclination allows for easy sighting in of the riflescope, even at longer distances.



CZ 457 LRP BLACK

A new version of this popular model for accurate, long range shooting. It comes with a 20" heavy and fluted cold hammer forged barrel, MATCH chamber and an effective cylindrical compensator mounted on the muzzle. All key features of its black, target-style stock are adjustable. A Picatinny mounting rail with 25 MOA inclination allows for easy sighting in of the riflescope.

MODEL	CALIBER (TWIST RATE) / NUMBER OF GROOVES	MAGAZINE CAPACITY	WEIGHT (kg)	LENGTH (mm)	BARREL LENGTH ("/ mm)	BARREL PROFILE	SIGHTS	THREAD	COMPENSATOR	STOCK	FINISH	CHEEKPIECE	LOP (mm)	TRIGGER	TRIGGER PULL WEIGHT (N)
CZ 457 MDT	22 LR (1:16) / 6	5	3,4	1010	20 / 525	Heavy, Fluted	No	1/2 x 20	Yes	Duralumin	Cerakote	Adjustable	335-360	Adjustable	11,1-14
CZ 457 LRP BLACK	22 LR (1:16) / 6	5	3,9	1010	20 / 525	Heavy, Fluted	No	1/2 x 20	Yes	Beech	Soft-touch	Adjustable	351-382	Adjustable	11,1-14

CZ 457 AT-ONE

The CZ 457 AT-ONE sport model from the CZ-USA range, which is held in high regard by our customers, is part of our worldwide offer of the CZ 457 series. This specially designed rifle is equipped with a varmint barrel with MATCH chamber and a solid laminated wood stock from the well-known American brand Boyds, which features an easily adjustable butt pad and comb. Classic sling loops are complemented by a quick-release loop with anchor holes on both sides of the stock.



CZ 457 THUMBHOLE

The perfect combination of ergonomics and elegance. The defining characteristic of this model is its thumbhole stock made from high-strength, gray-brown laminated wood, which also features a unique integrated trigger guard. Its sophisticated stock design allows for comfortable use by both right- and left-handed shooters.

MODEL	CALIBER (TWIST RATE) / NUMBER OF GROOVES	MAGAZINE CAPACITY	WEIGHT (kg)	LENGTH (mm)	BARREL LENGTH ("/ mm)	BARREL PROFILE	SIGHTS	THREAD	COMPENSATOR	STOCK	FINISH	CHEEKPIECE	LOP (mm)	TRIGGER	TRIGGER PULL WEIGHT (N)
CZ 457 AT-ONE	22 LR (1 : 16) / 6	5	3,5	935-982	20 / 525	Heavy	No	1/2 × 20	No	Laminated	Varnish	Adjustable	313-360	Adjustable	11,1-14
CZ 457 THUMBHOLE 16"	22 LR (1 : 16) / 6	5	3,2	885	16 / 412,5	Heavy	No	1/2 × 20	Yes	Laminated	Varnish	Yes	360	Adjustable	11,1-14
CZ 457 THUMBHOLE 20"	17 HMR (1 : 9) / 6	5	3,6	997	20 / 525	Heavy	No	1/2 × 20	Yes	Laminated	Varnish	Yes	360	Adjustable	11,1-14
CZ 457 THUMBHOLE 20"	22 LR (1 : 16) / 6	5	3,5	997	20 / 525	Heavy	No	1/2 × 20	Yes	Laminated	Varnish	Yes	360	Adjustable	11,1-14
CZ 457 THUMBHOLE 20"	22 WMR (1 : 16) / 6	5	3,5	997	20 / 525	Heavy	No	1/2 × 20	Yes	Laminated	Varnish	Yes	360	Adjustable	11,1-14

CZ 457 STAINLESS

A trail model created for those who appreciate the use of premium materials. Along with the many strengths of the CZ 457 series, this 22 LR caliber rifle features a modern digital camouflage pattern on its high comfort, soft-touch finished polymer stock and comes with a light profile, weather-resistant stainless steel barrel.



CZ 457 SYNTHETIC

The main feature for this model is increased resistance to adverse environmental conditions. All metal components come with a high quality, anti-corrosion finish. Its ergonomically friendly, and extremely strong, polymer stock comes with a soft-touch finish and is resistant to moisture, cold and heat.

MODEL	CALIBER (TWIST RATE) / NUMBER OF GROOVES	MAGAZINE CAPACITY	WEIGHT (kg)	LENGTH (mm)	BARREL LENGTH (" / mm)	BARREL PROFILE	SIGHTS	THREAD	COMPENSATOR	STOCK	FINISH	CHEEKPIECE	LOP (mm)	TRIGGER	TRIGGER PULL WEIGHT (N)
CZ 457 STAINLESS	22 LR (1:16) / 6	5	2,5	977	20 / 525	Light	No	1/2 x 20	No	Polymer	Soft-touch	No	356	Adjustable	11,1-14
CZ 457 SYNTHETIC 16"	22 LR (1:16) / 6	5	2,3	865	16 / 412,5	Light	No	1/2 x 20	No	Polymer	Soft-touch	No	356	Adjustable	11,1-14
CZ 457 SYNTHETIC 20"	17 HMR (1:9) / 6, 22 LR (1:16) / 6, 22 WMR (1:16) / 6	5	2,5	977	20 / 525	Light	No	1/2 x 20	No	Polymer	Soft-touch	No	356	Adjustable	11,1-14

CZ 457 VARMINT SYNTHETIC

A model created at the request of our customers. It's an ideal choice for accurate sport shooting and hunting at medium to longer distances, due to its heavy barrel and polymer stock with increased resistance to adverse weather conditions.



CZ 457 VARMINT LH



This model is also available as a left-handed version.

CZ 457 VARMINT

A popular design with an American-style varnished stock and heavy 525 mm barrel, which makes it ideal for accurate sport shooting and hunting at medium to long distances. The proven 11 mm CZ dovetail is milled into the top of the receiver for attaching riflescope ringmounts.



CZ 457 MTR

A highly precise model with an extraordinarily comfortable stock made from premium walnut. The heavy, cold hammer forged match-grade barrel in 22 LR caliber is equipped with a MATCH chamber. Thanks to this feature, together with other innovations in the CZ 457 series, the CZ 457 MTR guarantees 15 mm groups at a distance of 50 m.

MODEL	CALIBER (TWIST RATE) / NUMBER OF GROOVES	MAGAZINE CAPACITY	WEIGHT (kg)	LENGTH (mm)	BARREL LENGTH (mm) / (")	BARREL PROFILE	SIGHTS	THREAD	COMPENSATOR	STOCK	FINISH	CHEEKPIECE	LOP (mm)	TRIGGER	TRIGGER PULL WEIGHT (N)
CZ 457 VARMINT SYNTHETIC 16"	17 HMR (1:9) / 6, 22 LR (1:16) / 6	5	2,6	865	16 / 412,5	Heavy	No	1/2 x 20	No	Polymer	Soft-touch	No	356	Adjustable	11,1-14
CZ 457 VARMINT SYNTHETIC 20"	22 LR (1:16) / 6	5	2,9	977	20 / 525	Heavy	No	1/2 x 20	No	Polymer	Soft-touch	No	356	Adjustable	11,1-14
CZ 457 VARMINT	17 HMR (1:9) / 6, 22 LR (1:16) / 6, 22 WMR (1:16) / 6	5	3,3	981	20 / 525	Heavy	No	1/2 x 20	No	Walnut	Varnish	No	360	Adjustable	11,1-14
CZ 457 VARMINT LH	22 LR (1:16) / 6	5	3,3	981	20 / 525	Heavy	No	1/2 x 20	No	Walnut	Varnish	No	360	Adjustable	11,1-14
CZ 457 MTR 16"	22 LR (1:16) / 6	5	3,5	859	16 / 412,5	Heavy	No	1/2 x 20	No	Walnut	Oil	No	350	Adjustable	11,1-14
CZ 457 MTR 20"	22 LR (1:16) / 6	5	3,5	976	20 / 525	Heavy	No	1/2 x 20	No	Walnut	Oil	No	350	Adjustable	11,1-14

CZ 457 AMERICAN

A beautiful, modern example of a classic American sport shooting and hunting rimfire rifle. The varnished American-style stock is made from high quality walnut, with checkering on the grip that incorporates a fleur-de-lis motif. The light profile, cold hammer forged barrel is 630 mm long and has no sights.



This model is also available as a left-handed version.

CZ 457 AMERICAN LH



MODEL	CALIBER (TWIST RATE) / NUMBER OF GROOVES	MAGAZINE CAPACITY	WEIGHT (kg)	LENGTH (mm)	BARREL LENGTH ("/ mm)	BARREL PROFILE	SIGHTS	THREAD	COMPENSATOR	STOCK	FINISH	CHEEKPIECE	LOP (mm)	TRIGGER	TRIGGER PULL WEIGHT (N)
CZ 457 AMERICAN	17 HMR (1:9) / 6, 22 LR (1:16) / 6, 22 WMR (1:16) / 6	5	3,0	1087	24 / 630	Light	No	1/2 x 20	No	Walnut	Varnish	No	360	Adjustable	11,1-14
CZ 457 AMERICAN LH	22 LR (1:16) / 6	5	3,0	1087	24 / 630	Light	No	1/2 x 20	No	Walnut	Varnish	No	360	Adjustable	11,1-14

CZ 457 JAGUAR XII

The CZ 457 JAGUAR XII is a modern version of the popular rimfire rifles from CZ. It features the longest barrel on offer (726 mm), as well as a tangent rear sight adjustable between 25 and 200 m, stock with a jaguar motif, and claw marks in place of traditional checkering. Standard accessories include a 10-round metal magazine.



This model is also available as a left-handed version.

CZ 457 PREMIUM

The CZ 457 PREMIUM is a model that will impress all fans of classically shaped hunting rifles. Its premium walnut stock features a cheekpiece and decorative forend from high-grade material. The 630 mm light profile barrel has a 1/2 x 20 muzzle thread for the attachment of a suppressor. Aiming is quick and intuitive with its tangent rear sight and fiber optic front sight.

CZ 457 PREMIUM LH



MODEL	CALIBER (TWIST RATE) / NUMBER OF GROOVES	MAGAZINE CAPACITY	WEIGHT (kg)	LENGTH (mm)	BARREL LENGTH (" / mm)	BARREL PROFILE	SIGHTS	THREAD	COMPENSATOR	STOCK	FINISH	CHEEKPIECE	LOP (mm)	TRIGGER	TRIGGER PULL WEIGHT (N)
CZ 457 JAGUAR XII	22 LR (1:16) / 12	10	3,3	1182	28 / 726	Light	Yes	1/2 x 20	No	Beech	Varnish	Yes	360	Adjustable	11,1-14
CZ 457 PREMIUM	17 HMR (1:9) / 6, 22 LR (1:16) / 6, 22 WMR (1:16) / 6	5	3,2	1085	24 / 630	Light	Yes	1/2 x 20	No	Walnut	Oil	Yes	360	Adjustable	11,1-14
CZ 457 PREMIUM LH	22 LR (1:16) / 6	5	3,2	1085	24 / 630	Light	Yes	1/2 x 20	No	Walnut	Oil	Yes	360	Adjustable	11,1-14

CZ 457 LUX

An accurate, safe, reliable and modern rimfire rifle with a classic European centerfire hunting rifle design. The varnished stock with cheekpiece is made of high-quality Turkish walnut and features laser-etched checkering on the grip. Traditional iron sights come as standard.



CZ 457 TRAINING RIFLE XII

CZ rimfire rifles with the Training Rifle moniker have traditionally been the ideal firearm for novice shooters of all ages. In this case, it is all the more true thanks to the benefits of the CZ 457 series that significantly increase user safety, accuracy and the rifle's service life. Like the CZ 457 JAGUAR XII, the barrel on this model comes with a 12 groove bore.



MODEL	CALIBER (TWIST RATE) / NUMBER OF GROOVES	MAGAZINE CAPACITY	WEIGHT (kg)	LENGTH (mm)	BARREL LENGTH (" / mm)	BARREL PROFILE	SIGHTS	THREAD	COMPENSATOR	STOCK	FINISH	CHEEKPIECE	LOP (mm)	TRIGGER	TRIGGER PULL WEIGHT (N)
CZ 457 LUX	17 HMR (1 : 9) / 6, 22 LR (1 : 16) / 6, 22 WMR (1 : 16) / 6	5	2,9	1088	24 / 630	Light	Yes	1/2 × 20	No	Walnut	Varnish	Yes	360	Adjustable	11,1-14
CZ 457 TRAINING RIFLE XII	22 LR (1 : 16) / 12	5	3,1	1085	24 / 630	Light	Yes	1/2 × 20	No	Beech	Varnish	Yes	360	Adjustable	11,1-14

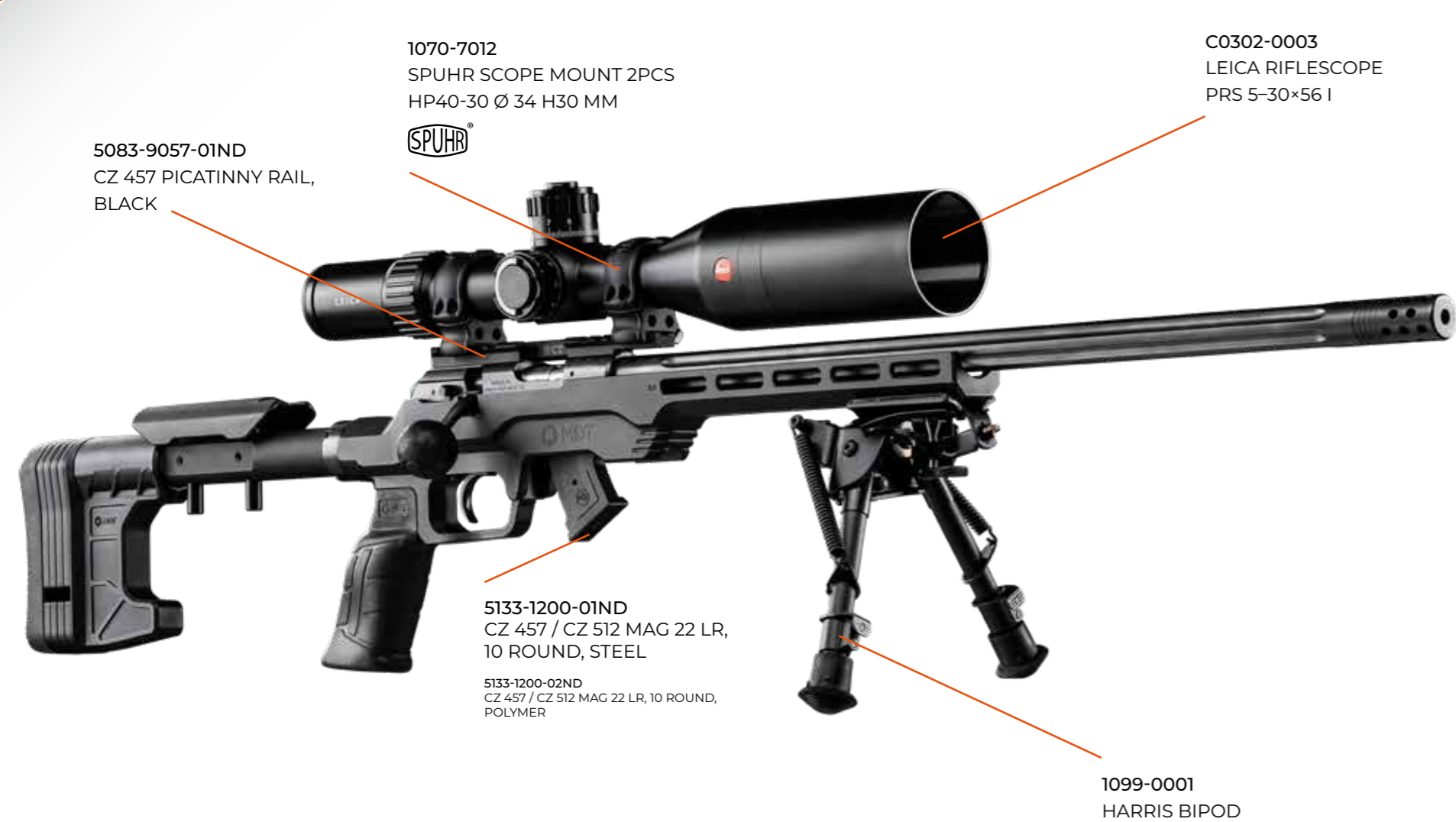

RECOMMENDED
ACCESSORIES

MODEL	CALIBER (TWIST RATE) / NUMBER OF GROOVES	MAGAZINE CAPACITY	WEIGHT (kg)	LENGTH (mm)	BARREL LENGTH ("/ mm)	BARREL PROFILE	SIGHTS	THREAD	COMPENSATOR	STOCK	FINISH	CHEEKPIECE	LOP (mm)	TRIGGER	TRIGGER PULL WEIGHT (N)
CZ 457 CARBON	22 LR (1:16) / 6	5	2,15	977	20 / 525	Carbon fiber-wrapped steel	No	1/2 × 20	No	Polymer	Soft-touch	No	356	Adjustable	11,1-14
CZ 457 RANGE 20"	22 LR (1:16) / 6	5	3,7	980	20 / 525	Varmint Match	No	1/2 × 20	No	Laminated Wood	Varnish	Adjustable	365	Single-stage	11,1-14
CZ 457 RANGE 24"	22 LR (1:16) / 6	5	4	990	24 / 610	Varmint Match	No	1/2 × 20	No	Laminated Wood	Varnish	Adjustable	365	Single-stage	11,1-14
CZ 457 ERGO with sights	22 LR (1:16) / 6	5	2,3	976	20 / 525	Light	Yes	1/2 × 20	No	Polymer	–	Detachable	365	Adjustable	11,1-14
CZ 457 ERGO BM without sights	22 LR (1:16) / 6	5	2,3	976	20 / 525	Light	No	1/2 × 20	No	Polymer	–	Detachable	365	Adjustable	11,1-14
CZ 457 MDT	22 LR (1:16) / 6	5	3,4	1010	20 / 525	Heavy, Fluted	No	1/2 × 20	Yes	Duralumin	Cerakote	Adjustable	335-360	Adjustable	11,1-14
CZ 457 LRP BLACK	22 LR (1:16) / 6	5	3,9	1010	20 / 525	Heavy, Fluted	No	1/2 × 20	Yes	Beech	Soft-touch	Adjustable	351-382	Adjustable	11,1-14
CZ 457 AT-ONE	22 LR (1:16) / 6	5	3,5	935-982	20 / 525	Heavy	No	1/2 × 20	No	Laminated	Varnish	Adjustable	313-360	Adjustable	11,1-14
CZ 457 THUMBHOLE 16"	22 LR (1:16) / 6	5	3,2	885	16 / 412,5	Heavy	No	1/2 × 20	Yes	Laminated	Varnish	Yes	360	Adjustable	11,1-14
CZ 457 THUMBHOLE 20"	17 HMR (1:9) / 6	5	3,6	997	20 / 525	Heavy	No	1/2 × 20	Yes	Laminated	Varnish	Yes	360	Adjustable	11,1-14
CZ 457 THUMBHOLE 20"	22 LR (1:16) / 6	5	3,5	997	20 / 525	Heavy	No	1/2 × 20	Yes	Laminated	Varnish	Yes	360	Adjustable	11,1-14
CZ 457 THUMBHOLE 20"	22 WMR (1:16) / 6	5	3,5	997	20 / 525	Heavy	No	1/2 × 20	Yes	Laminated	Varnish	Yes	360	Adjustable	11,1-14
CZ 457 STAINLESS	22 LR (1:16) / 6	5	2,5	977	20 / 525	Light	No	1/2 × 20	No	Polymer	Soft-touch	No	356	Adjustable	11,1-14
CZ 457 SYNTHETIC 16"	22 LR (1:16) / 6	5	2,3	865	16 / 412,5	Light	No	1/2 × 20	No	Polymer	Soft-touch	No	356	Adjustable	11,1-14
CZ 457 SYNTHETIC 20"	17 HMR (1:9) / 6, 22 LR (1:16) / 6, 22 WMR (1:16) / 6	5	2,5	977	20 / 525	Light	No	1/2 × 20	No	Polymer	Soft-touch	No	356	Adjustable	11,1-14
CZ 457 VARMINT SYNTHETIC 16"	17 HMR (1:9) / 6, 22 LR (1:16) / 6	5	2,6	865	16 / 412,5	Heavy	No	1/2 × 20	No	Polymer	Soft-touch	No	356	Adjustable	11,1-14
CZ 457 VARMINT SYNTHETIC 20"	22 LR (1:16) / 6	5	2,9	977	20 / 525	Heavy	No	1/2 × 20	No	Polymer	Soft-touch	No	356	Adjustable	11,1-14
CZ 457 VARMINT	17 HMR (1:9) / 6, 22 LR (1:16) / 6, 22 WMR (1:16) / 6	5	3,3	981	20 / 525	Heavy	No	1/2 × 20	No	Walnut	Varnish	No	360	Adjustable	11,1-14
CZ 457 VARMINT LH	22 LR (1:16) / 6	5	3,3	981	20 / 525	Heavy	No	1/2 × 20	No	Walnut	Varnish	No	360	Adjustable	11,1-14
CZ 457 MTR 16"	22 LR (1:16) / 6	5	3,5	859	16 / 412,5	Heavy	No	1/2 × 20	No	Walnut	Oil	No	350	Adjustable	11,1-14
CZ 457 MTR 20"	22 LR (1:16) / 6	5	3,5	976	20 / 525	Heavy	No	1/2 × 20	No	Walnut	Oil	No	350	Adjustable	11,1-14
CZ 457 AMERICAN	17 HMR (1:9) / 6, 22 LR (1:16) / 6, 22 WMR (1:16) / 6	5	3,0	1087	24 / 630	Light	No	1/2 × 20	No	Walnut	Varnish	No	360	Adjustable	11,1-14
CZ 457 AMERICAN LH	22 LR (1:16) / 6	5	3,0	1087	24 / 630	Light	No	1/2 × 20	No	Walnut	Varnish	No	360	Adjustable	11,1-14
CZ 457 JAGUAR XII	22 LR (1:16) / 12	10	3,3	1182	28 / 726	Light	Yes	1/2 × 20	No	Beech	Varnish	Yes	360	Adjustable	11,1-14
CZ 457 PREMIUM	17 HMR (1:9) / 6, 22 LR (1:16) / 6, 22 WMR (1:16) / 6	5	3,2	1085	24 / 630	Light	Yes	1/2 × 20	No	Walnut	Oil	Yes	360	Adjustable	11,1-14
CZ 457 PREMIUM LH	22 LR (1:16) / 6	5	3,2	1085	24 / 630	Light	Yes	1/2 × 20	No	Walnut	Oil	Yes	360	Adjustable	11,1-14
CZ 457 LUX	17 HMR (1:9) / 6, 22 LR (1:16) / 6, 22 WMR (1:16) / 6	5	2,9	1088	24 / 630	Light	Ano	1/2 × 20	No	Walnut	Varnish	Ano	360	Adjustable	11,1-14
CZ 457 TRAINING RIFLE XII	22 LR (1:16) / 12	5	3,1	1085	24 / 630	Light	Ano	1/2 × 20	No	Beech	Varnish	Ano	360	Adjustable	11,1-14





SHOTGUNS CZ-USA FIELD SPORTS

Borrowing from the most popular firearms in the CZ-USA portfolio, this diverse range of shotguns exhibits excellent construction quality, reliability and user-friendliness. The traditional core offer is a proven range of semi-automatic and pump action shotgun models for hunting and sport shooting, for which a wide selection of interchangeable chokes is available. There's something for everyone on the following pages.



CZ SUPREME FIELD

An elegant over/under shotgun made for shooters who require more than just accuracy and reliability from their firearm. The beautiful CNC machined receiver is chrome plated, polished and hand engraved. The stock is made from carefully selected Turkish walnut (Grade III) and features a beautiful image. Additional features include ejectors and a single trigger mechanism that allows you to choose firing order of the barrels.

CZ REDHEAD PREMIER

A high level, universal 12-gauge over/under shotgun designed for sport shooting and hunting. The precision CNC machined receiver is chrome plated, which gives it a shiny silver appearance. This model is equipped with ejectors for the fastest reloading times and a single trigger mechanism that allows you to choose the barrel firing order.

NEW

CZ REDHEAD PREMIER TARGET

The CZ Redhead Premier Target shotgun offers a unique shooting experience thanks to its ergonomically designed Monte Carlo-style stock. This is accompanied by a pair of 30" barrels with five interchangeable chokes, a trigger mechanism allowing for easy and convenient firing of each barrel, and cross-bolt safety for maximum safety.

MODEL	CHAMBERING	CAPACITY	WEIGHT (kg)	LENGTH (mm)	BARREL LENGTH ("/mm)	STOCK	FINISH	CHEEKPIECE	LOP (mm)	CHOKE	EJECTOR/EXTRACTOR	1ST TRIGGER PULL WEIGHT (N)	2ND TRIGGER PULL WEIGHT (N)
CZ SUPREME FIELD	12/76	2	3,5	1160	28 / 710	Walnut	Varnish	No	355	Multi (5 pcs)	Ejectors	16	16
CZ REDHEAD PREMIER	12/76	2	3,5	1160	28 / 710	Walnut	Varnish	No	355	Multi (5 pcs)	Ejectors	19,5	15,5
NEW CZ REDHEAD PREMIER TARGET	12/76	2	3,6	1225	30 / 710	Walnut	Varnish	No	356	Multi (5 pcs)	Ejectors	19	



NEW

CZ BOBWHITE G2

An updated version of our traditionally-styled Bobwhite, the CZ BOBWHITE G2 model features a CNCed receiver and modern internals that slim the action, while increasing service life and reliability. With double triggers and a straight, English-style grip, quick choke decisions can be made on the fly.



CZ DRAKE

The CZ DRAKE is an over/under shotgun with an extremely advantageous price to performance ratio. CNC machining of components is also utilized for this model. Features include extractor operation, a single selectable trigger mechanism with the ability to choose the firing order of barrels, low weight due to the deletion of the mid-rib between barrels, and laser cut checkering for a slip-free grip.



Finished in hardy black chrome, the CZ BOBWHITE G2 will resist rust much better than a blued gun. Its 28" barrels are threaded for choke tubes and it ships with five flush chokes – from Cylinder to Full.

MODEL	CHAMBERING	CAPACITY	WEIGHT (kg)	LENGTH (mm)	BARREL LENGTH ("/mm)	STOCK	FINISH	CHEEKPIECE	LOP (mm)	CHOKE	EJECTOR/EXTRACTOR	1ST TRIGGER PULL WEIGHT (N)	2ND TRIGGER PULL WEIGHT (N)
CZ DRAKE	12/76	2	3,3	1160	28 / 710	Walnut	Varnish	No	355	Multi (5 pcs)	Extractor	19	17,5
CZ BOBWHITE G2	12/76	2	2,9	1140	28 / 710	Walnut	Varnish	No	355	Multi (5 pcs)	Extractor	19	18

CZ 1012

A 12-gauge semi-automatic shotgun with a gasless inertia operating system for maximum reliability. Its user-friendliness was confirmed with a test of 5,000 shots without a drop of oil or any type of cleaning, while experiencing zero parts breakage or malfunctions. This model is equipped with a stock and forend made from Turkish walnut.



CZ 1012 SYNTHETIC

A semi-automatic 12-gauge shotgun with a gasless inertia operating system, which provides maximum reliability with various types of ammunition, from light-recoiling target loads to powerful 3" magnums, and allows for a more relaxed maintenance schedule. A durable polymer stock makes it an ideal firearm for use in extremely inhospitable conditions. A wide range of chokes is also available for this model.



CZ 612 HOME DEFENSE

A simple 12-gauge pump action shotgun with a durable polymer stock and reduced length, 47 cm barrel with fixed cylinder choke. The result is a compact, reliable and powerful firearm especially suited for home defense, while also being a great choice for competing in IPSC disciplines.



CZ 612 FIELD

A reliable and affordable 12-gauge pump action shotgun for sport and hunting. The simple and durable pump reloading system has very low maintenance requirements, while the dual action bars make operation smooth and reliable. The stock is made of Turkish walnut and three interchangeable chokes come as part of its standard equipment.



MODEL	CHAMBERING	CAPACITY	WEIGHT (kg)	LENGTH (mm)	BARREL LENGTH ("/mm)	STOCK	FINISH	CHEEKPIECE	LOP (mm)	CHOKE	TRIGGER PULL WEIGHT (N)
CZ 1012	12/76	4	3,5	1285	28 / 710	Walnut	Varnish	Yes	355	Multi (5 pcs)	20
CZ 1012 SYNTHETIC	12/76	4	3,1	1285	28 / 710	Polymer	-	Yes	355	Multi (5 pcs)	20
CZ 612 HOME DEFENSE	12/76	4	2,6	970	18,5 / 470	Polymer	-	No	355	Fixed Cylinder	17
CZ 612 FIELD	12/76	4	2,8	1170	28 / 710	Walnut	Varnish	No	355	Multi (3 pcs)	17



SEMI-AUTOMATIC RIFLES / CARBINES

SEMI-AUTOMATIC RIFLES / CARBINES

The semi-automatic CZ SCORPION EVO 3 S1/S2 and CZ BREN 2 Ms series are among the world's elite in their respective categories. Their parameters and high level of performance make them an ideal choice for today's dynamic shooting sports, as well as maintaining shooting fitness and hobby shooting.

A person wearing a dark tactical cap with a 'HOLSTEN' patch and a dark jacket is holding a CZ Scorpion EVO 3 S1/S2 carbine. The carbine is black and features a red dot sight, a silencer, and a magazine. The person is holding the carbine with both hands, aiming it forward. The background is a blurred, dark blue-grey color.

ADVANCED SEMI-AUTOMATIC PISTOL CALIBER CARBINES FOR MODERN SPORTING DISCIPLINES

The unique design of the CZ SCORPION EVO 3 S1/S2 series offers its users many benefits, such as light weight, advanced ergonomics, high accuracy, comfortable handling, ease of disassembly, impressive reliability and extremely fast reloading.

CZ SCORPION
EVO 3 S1/S2
SERIES



NEW

CZ SCORPION EVO 3 S2 MICRO

MODEL	CALIBER	TWIST RATE / NUMBER OF GROOVES	MAGAZINE CAPACITY	BARREL LENGTH ("/ mm)	THREAD	SIGHTS	WEIGHT WITHOUT MAGAZINE (kg)	OVERALL LENGTH WITH STOCK FOLDED / UNFOLDED - FULLY EXTENDED (mm)	HEIGHT WITH FOLDED IRON SIGHTS, NO MAGAZINE (mm)
CZ SCORPION EVO 3 S2 MICRO (with stock)	9 × 19	1:10 / 6	10	5,5 / 140 ± 0,3	1/2" × 28 UNEF	Iron, Adjustable	2,6 ± 0,05	386 ± 10 / 584 – 634 ± 10	215 ± 5
CZ SCORPION EVO 3 S2 MICRO (without stock)	9 × 19	1:10 / 6	10	5,5 / 140 ± 0,3	1/2" × 28 UNEF	Iron, Adjustable	2,2 ± 0,05	386 ± 10 / 386 ± 10	215 ± 5



A 9 × 19 caliber model based on the internationally popular CZ SCORPION EVO 3 pistol caliber carbine series. Despite a barrel length of only 140 mm, it retains high accuracy. The spiral three-arm flash hider effectively contributes to its impressive shooting comfort. A short forend made from highly durable aluminum alloy, with mounted hand stop, ensures a safe and reliable grip. Picatinny and M-LOK mounting interfaces are also at the user's disposal.



WIDTH WITH STOCK UNFOLDED / FOLDED (mm)	TRIGGER PULL WEIGHT (N)	FRAME
60 ± 5 / 82 ± 5	48 ± 10	Fiberglass-reinforced polymer
60 ± 5	48 ± 10	Fiberglass-reinforced polymer

**HIGHLY COMPACT
SEMI-AUTOMATIC
FIREARM FOR PISTOL
CALIBER CARTRIDGES**



Magazine
is not included
in the package.

CZ SCORPION EVO 3 S1

A semi-automatic rifle chambered for pistol cartridges. Its simple design, extreme reliability, light weight, easy handling and accuracy make it the perfect fit for modern shooting sports and hobby shooting.



CZ SCORPION EVO 3 S1 CARBINE

A highly accurate and reliable semi-automatic carbine with a 16" barrel that's fitted with an attractive faux-suppressor. Its long, fiberglass-reinforced polymer forend is equipped with a modern M-LOK attachment system for comfortable handling.



CZ SCORPION EVO 3 S1 CARBINE COMP

The increased shooting comfort of this model is due to an effective two-chamber muzzle brake fitted on its 16" barrel and a long forend equipped with the M-LOK attachment system. It's a first-class firearm for modern sport and hobby shooting.

MODEL	CALIBER	TWIST RATE / NUMBER OF GROOVES	MAGAZINE CAPACITY	BARREL LENGTH (" / mm)	THREAD	SIGHTS	WEIGHT WITHOUT MAGAZINE (kg)	OVERALL LENGTH WITH STOCK FOLDED / UNFOLDED - FULLY EXTENDED (mm)	HEIGHT WITH FOLDED IRON SIGHTS, NO MAGAZINE (mm)	WIDTH WITH STOCK UNFOLDED / FOLDED (mm)	TRIGGER PULL WEIGHT (N)	FRAME
CZ SCORPION EVO 3 S1	9 × 19	1:10 / 6	-	7,7 / 196 ± 1	1/2" × 28 UNEF	Iron, Adjustable	2,55 ± 0,05	420 / 615-665 ± 10	215 ± 5	60 / 82 ± 5	48 ± 10	Fiberglass-reinforced polymer
CZ SCORPION EVO 3 S1 CARBINE	9 × 19	1:10 / 6	-	16,2 / 412 ± 1	1/2" × 28 UNEF	Iron, Adjustable	3,05 ± 0,05	630 / 830-880 ± 10	215 ± 5	60 / 82 ± 5	48 ± 10	Fiberglass-reinforced polymer
CZ SCORPION EVO 3 S1 CARBINE COMP	9 × 19	1:10 / 6	-	16,2 / 412 ± 1	1/2" × 28 UNEF	Iron, Adjustable	3,05 ± 0,05	665 / 860-910 ± 10	215 ± 5	60 / 82 ± 5	48 ± 10	Fiberglass-reinforced polymer

NEW

CZ SCORPION EVO 3 S1 22 LR

Exclusive, semi-automatic models for sport shooting with 22 LR cartridges. Both retain all advantages of the globally popular series, in addition to minimal recoil. Their dynamic bolt is optimized for reliable operation with all types of cartridges. Both models are equipped with a folding/telescopic shoulder stock, adjustable mechanical sights and a 10 round polymer magazine.



NEW

CZ SCORPION EVO 3 S1 CARBINE COMP 22 LR

MODEL	CALIBER	TWIST RATE / NUMBER OF GROOVES	MAGAZINE CAPACITY	BARREL LENGTH ("/ mm)	THREAD	SIGHTS	WEIGHT WITHOUT MAGAZINE (kg)	OVERALL LENGTH WITH STOCK FOLDED / UNFOLDED - FULLY EXTENDED (mm)	HEIGHT WITH FOLDED IRON SIGHTS, NO MAGAZINE (mm)	WIDTH WITH STOCK UNFOLDED / FOLDED (mm)	TRIGGER PULL WEIGHT (N)	FRAME
CZ SCORPION EVO 3 S1 CARBINE COMP	22 LR	1:10 / 6	10	16 / 416 ± 0,3	1/2" × 28 UNEF	Iron, Adjustable	2,7 ± 0,05	665 / 860-910 ± 10	215 ± 5	60 / 82 ± 5	33 ± 5	Fiberglass-reinforced polymer
CZ SCORPION EVO 3 S1 8"	22 LR	1:16 / 6	10	8 / 200 ± 0,3	M18 × 1	Iron, Adjustable	2,22 ± 0,05	420 / 615-665 ± 10	215 ± 5	60 / 82 ± 5	33 ± 5	Fiberglass-reinforced polymer





**RECOMMENDED
ACCESSORIES**



A0216-0000
ACRO WEAVER MOUNT
QD 39MM 200519

B0101-0001
AIMPOINT ACRO C-2
RED DOT SIGHT

A0203-0013
TACT. FLASHLIGHT
WML 450 LM IF71011

A0105-0002
FRONT HAND GUARD
FOR CZ SCORPION EVO 3,
M-LOK

3662-0800-0715ND
CZ MAG 9 × 19, 10 ROUND

A man with a beard and glasses, wearing a dark cap with a CZ logo and a dark t-shirt, is holding a CZ BREN 2 Ms semi-automatic rifle. He is looking directly at the camera with a serious expression. The background is dark with a grid of circular patterns, possibly a wall or a target. The lighting is dramatic, highlighting the man's face and the rifle. A large orange diagonal shape is on the left side of the page.

CUTTING-EDGE SEMI-AUTOMATIC RIFLES WITH IMPRESSIVE PARAMETERS

The CZ BREN 2 Ms semi-automatic platform is one of the most sophisticated on the global market. Its advantages include a simple design, extreme reliability, high accuracy, low weight and excellent ergonomics, as well as ambidextrous and easy to swap controls.

CZ BREN 2 Ms
SERIES

CZ BREN 2 Ms

The semi-automatic CZ BREN 2 Ms rifle is chambered in the popular 223 Rem. caliber. It features a short, interchangeable forend and 280 mm barrel. Despite its compact dimensions, it's a highly accurate firearm. Standard equipment includes mechanical sights.



CZ BREN 2 Ms

This model combines the outstanding design features of the CZ BREN 2 Ms series with the impressive ballistic performance of the 7,62 × 39 cartridge. Standard equipment includes mechanical sights.



CZ BREN 2 Ms CARBINE

The CZ BREN 2 Ms semi-automatic carbine is chambered in the popular 223 Rem. caliber. It comes with a long, interchangeable forend, 425 mm barrel and extended folding/telescopic shoulder stock with raised comb. Its design is optimized for accurate shooting, even at longer distances. Standard equipment includes mechanical sights.



MODEL	CALIBER	TWIST RATE / NUMBER OF GROOVES	MAGAZINE CAPACITY	BARREL LENGTH ("/ mm)	THREAD	SIGHTS	WEIGHT WITHOUT MAGAZINE (kg)	OVERALL LENGTH WITH STOCK FOLDED / UNFOLDED - FULLY EXTENDED (mm)	HEIGHT WITH FOLDED IRON SIGHTS, NO MAGAZINE (mm)	WIDTH WITH STOCK UNFOLDED / FOLDED (mm)	TRIGGER PULL WEIGHT (N)	UPPER RECEIVER
CZ BREN 2 Ms 11"	223 Rem.	1:7/6	–	11/280 ± 1	1/2" × 28 UNEF	Iron, Folding, Adjustable	3,13 ± 0,05	577 / 762–807 ± 10	202 ± 5	80 / 104 ± 5	16 ± 4	7075 T6 aluminum alloy
CZ BREN 2 Ms 11"	7,62 × 39	1:9,45/4	–	11/280 ± 1	M14 × 1 LH	Iron, Folding, Adjustable	3,03 ± 0,05	577 / 762–807 ± 10	202 ± 5	80 / 104 ± 5	16 ± 4	7075 T6 aluminum alloy
CZ BREN 2 Ms CARBINE	223 Rem.	1:7/6	–	16,5/425 ± 1	1/2 × 28 UNEF	Iron, Folding, Adjustable	3,45 ± 0,05	719 / 909–980 ± 10	202 ± 5	80 / 104 ± 5	16 ± 4	7075 T6 aluminum alloy



**RECOMMENDED
ACCESSORIES**

A0201-0017
AIMPOINT DUTY RDS
2 MOA RED DOT SIGHT

A0201-0018
AIMPOINT MAGNIFIER
3×MAG-C



3722-3500-6503ND
CZ MAG 5,56 × 45, 10 ROUND

**ACCESSORIES
PISTOLS**



1091-1341-03
CZ 75 SP-01 AL MAGAZINE BASE PLATE – RED

1091-1341-04
BLUE

1091-1341-02
SILVER

1091-1341-01
BLACK



1091-1342-03
CZ TS AL MAGAZINE BASE PLATE – RED

1091-1342-04
BLUE

1091-1342-02
SILVER

1091-1342-01
BLACK



1091-1345-05
CZ SHADOW 2 ALU BASE PLATE FOR MAGWELL – PURPLE

1091-1345-11
BLACK

1091-1345-12
SILVER

1091-1345-14
BLUE



1091-1148-01
CZ TS WIDE MAGWELL – BLACK

1091-1148-02
SILVER

1091-1148-03
RED

1091-1148-04
BLUE

1091-1148-05
ORANGE



1091-2280-01
CZ SHADOW 2 MAGWELL – BLACK (HARD ELOX)

1091-2280-03
RED

1091-2280-05
PURPLE

1091-2280-12
SILVER

1091-2280-14
BLUE

B0306-0001
CZ SHADOW 2 COMPACT FLAT ALU BASE PLATE – BLUE

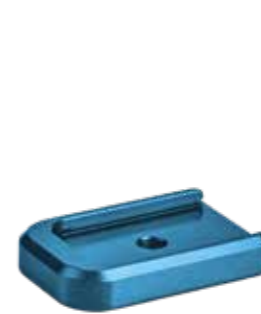

B0306-0002
BLACK

B0306-0003
RED

B0306-0004
GREEN

B0306-0005
PURPLE

B0306-0006
SILVER

B0306-0007
CZ SHADOW 2 ALU +2 BASE PLATE – BLUE



B0306-0008
BLACK

B0306-0009
RED

B0306-0010
GREEN

B0306-0011
PURPLE

B0306-0012
SILVER

B0305-0000
CZ SHADOW 2 COMPACT ALU MAGAZINE RELEASE BUTTON – BLUE

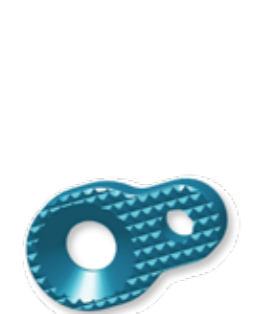

B0305-0001
BLACK

B0305-0002
RED

B0305-0003
GREEN

B0305-0004
PURPLE

B0305-0010
SILVER



0470-0080-1604ND
SLIDE RELEASE PIN FOR CZ TS 2



1091-2180-05
CZ SHADOW 2 GRIPS – PURPLE (HARD ANODIZED)

1091-2180-11
BLACK (HARD ANODIZED)

1091-2180-12
SILVER (HARD ANODIZED)

1091-2180-14
BLUE (HARD ANODIZED)



B0105-0013
CZ TS 2 LONG GRIPS – BLACK

B0105-0024
RED

B0105-0015
BLUE

B0105-0014
GREEN

B0105-0016
GREY



B0105-0022
CZ TS 2 SHORT GRIPS – GREEN

B0105-0011
BLACK

B0105-0023
RED

B0105-0012
BLUE

B0105-0025
SILVER



B0305-0005
CZ SHADOW 2 COMPACT GRIPS – BLUE

B0305-0008
GREEN

B0305-0006
BLACK

B0305-0007
RED

B0305-0011
SILVER

B0305-0009
PURPLE



1091-1352
CZ TS 2 THUMBREST 20° ANGLE (RACING GREEN)

1091-1353
CZ TS 2 THUMBREST 48° ANGLE (ORANGE)

1091-1354
CZ TS 2 THUMBREST SHORTENED 20,5° ANGLE (DEEP BRONZE)



1091-1320
SA | DA HAMMER



1091-1321
SA HAMMER (CZ SHADOW, CZ TS)



1091-1337
CZ 75 SP-01 / CZ SHADOW / CZ TS / CZ TS 2 SAFETY SET (L) WIDE



1091-1338
CZ 75 SP-01 / CZ SHADOW 2 / CZ TS / CZ TS 2 SAFETY SET (R) WIDE



1091-1312-01
CZ TS 2 TRIGGER, BLACK



0471-0081-1606ND
CZ SHADOW 2 / CZ TS FLAT SLIDE RELEASE



0423-2500-02ND
CZ 75 SP-01 / CZ SHADOW 2 / CZ TS / CZ TS 2 SAFETY SET (R)



1091-1224
CZ 75 SP-01 SHADOW / CZ 75 SP-01 SHADOW ORANGE FLAT SAFETY SET

1091-1336
CZ 75 SP-01 SHADOW / CZ 75 SP-01 SHADOW ORANGE SAFETY SET – RIGHT-HANDERS



1091-1335
CZ SHADOW 2 / CZ SHADOW 2 COMPACT / CZ TS / CZ TS 2 WIDE SAFETY SET



0422-0710-14ND
CZ 75 SP-01 / CZ SHADOW 2
9 x 19 MAGAZINE, 17 ROUND, AFC

0422-0710-15ND
CZ SP-01 / CZ SHADOW 2
MAGAZINE, 19 ROUND, AFC

0422-0710-17ND
CZ 75 / CZ 75 SP-01 SHADOW /
CZ SHADOW 2 / CZ 75
MAGAZINE, 19 ROUND

0472-3710-0706ND
CZ 75 TS 9 x 19 MAGAZINE, 20 ROUND



0472-3710-0713ND
CZ TS 2 RACING GREEN MAGAZINE,
20 ROUND, GREEN

0472-3710-0712ND
CZ TS 2 DEEP BRONZE MAGAZINE,
20 ROUND, BLACK
AL BASE PLATE (MAGWELL)

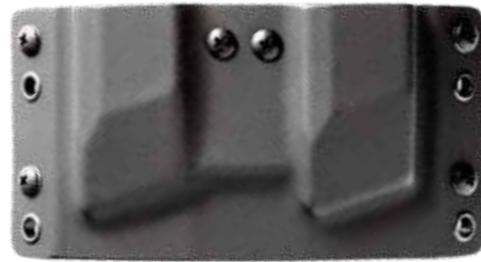

5125-1049
CZ 75 DOUBLE MAGAZINE POUCH



5125-1200
CZ TS 2 OWB KYDEX HOLSTER (R)

5125-1201
CZ TS 2 OWB KYDEX HOLSTER (L)



5125-1202
CZ TS 2 KYDEX SPORT HOLSTER (TEKLOK) (R)

5125-1203
CZ TS 2 KYDEX SPORT HOLSTER (TEKLOK) (L)



5118-0005-01
CZ SHADOW 2 NANUK CASE -
BLACK

5118-0005-02
OLIVE

5118-0005-03
TAN

5118-0005-04
GRAPHITE

5118-0005-05
SILVER

5118-0005-06
ORANGE



1091-1420-01
CZ SHADOW 2 OPTICS-READY
PLATE - TRIJICON RMR/SRO

1091-1420-06
CZ SHADOW 2 OR PLATE -
SHIELD RMS

1091-1420-04
CZ SHADOW 2 OR PLATE -
VENOM/DOCTER

B0101-0002
CZ SHADOW 2 OPTICS-READY
PLATE - ACRO



0422-0710-16ND
CZ 75 / CZ 75 SP-01 / CZ SHADOW 2
NICKEL MAGAZINE, 19 ROUND



0472-3710-1617ND
CZ TS / CZ TS 2 40 S&W MAGAZINE,
17 ROUND



5125-1048
CZ 75 MAGAZINE POUCH



B0115-0058
CZ SHADOW 2 COMPACT SHARKY
IWB KYDEX HOLSTER (R)



B0115-0057
CZ SHADOW 2 COMPACT FROGY
OWB KYDEX HOLSTER (R)

B0115-0045
CZ SHADOW 2 COMPACT
OWB KYDEX HOLSTER, 1/2 SWG (R)

**ACCESSORIES
PISTOLS**



0722-0030-10ND
CZ P-09 / CZ P-10 F
9 × 19 MAGAZINE, 19 ROUND, AFC

0532-0030-10ND
CZ P-10 F 45 AUTO
45 AUTO MAGAZINE, 13 ROUND

0722-0030-05ND
CZ P-09 / CZ P-10 F
9 × 19 MAGAZINE, 10 ROUND, AFC

0552-0030-10ND
CZ P-09 / CZ P-10 F
9 × 19 MAGAZINE, 15 ROUND, AFC, WH

0552-0030-04ND
CZ P-10 C / CZ P-07
9 × 19 MAGAZINE, 10 ROUND, AFC, WH

0552-0030-06ND
CZ P-10 C 9 × 19 MAGAZINE, 17 ROUND
(CAN BE USED FOR CZ P-07)



1081-0171
CZ P-10 GIS PSR 9/7 SUPPRESSOR (STANDARD)

B1081-0136M
CZ P-10 B&T STANDARD SUPPRESSOR 9 MM SD-988667 1/2"-28

B0107-0002M
SILENCER PMM-6 9 MM 1/2"-28



5125-1808
CZ P-10 M IWB KYDEX
MAGAZINE POUCH

5125-1809
CZ P-10 M OWB KYDEX
MAGAZINE POUCH

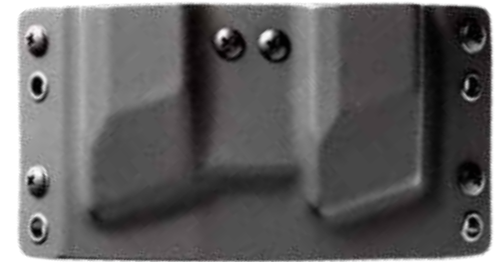

5125-1047
CZ P-07/09 KYDEX DOUBLE MAGAZINE POUCH

5125-1810
CZ P-10 M OWB KYDEX DOUBLE MAGAZINE POUCH



5118-0004-01
CZ P-10 NANUK CASE –
BLACK

5118-0004-02
OLIVE

5118-0004-03
TAN

5118-0004-04
GRAPHITE

5118-0004-05
SILVER



1091-1410-08
CZ P-10 OPTICS-READY ACRO PLATE

1091-1410-01
CZ P-10 OPTICS-READY PLATE –
RMR/SRO

1091-1410-03
CZ P-10 OR PLATE – DOCTER/VENOM

1091-1410-09
CZ P-10 OR PLATE, C-MORE



5125-1801
CZ P-10 M IWB KYDEX HOLSTER, 1/2 SWG (R)

5125-1802
CZ P-10 M IWB KYDEX HOLSTER, 1/2 SWG (L)

B0115-0031
CZ P-10 S IWB KYDEX HOLSTER,
FULL SWG 149 FLUSHCLIP (R)

B0115-0032
CZ P-10 C IWB KYDEX HOLSTER,
FULL SWG 149 FLUSHCLIP (R)

B0115-0037
CZ P-10 M IWB KYDEX HOLSTER,
FULL SWG 149 FLUSHCLIP (R)



5125-1803
CZ P-10 M OWB KYDEX HOLSTER (R)

5125-1804
CZ P-10 M OWB KYDEX HOLSTER (L)



5125-1230
CZ P-10 F, 45 AUTO OWB KYDEX HOLSTER, NO SWG (R)

5125-1231
CZ P-10 F, 45 AUTO OWB KYDEX HOLSTER, NO SWG (L)

5125-1232
CZ P-10 F, 45 AUTO OWB KYDEX HOLSTER, 1/2 SWG (R)

5125-1234
CZ P-10 F, 45 AUTO OWB KYDEX HOLSTER, FULL SWG (R)

5125-1235
CZ P-10 F, 45 AUTO OWB KYDEX HOLSTER, FULL SWG (L)



1091-1360
CZ P-10 AL ENLARGED MAGAZINE
BASE PLATE



1091-1380-01
CZ P-10 ANODIZED AL TRIGGER –
BLACK

1091-1380-02
RED

1091-1380-03
BLUE

1091-1380-04
GREEN

1091-1390-01
CZ P-10 MICRO AL TRIGGER –
BLACK

1091-1390-02
RED

1091-1390-03
BLUE

1091-1390-04
GREEN



B0115-0070
KYDEX POUZDRO OWB FROGY P10 C P.170

B0115-0072
KYDEX POUZDRO OWB FROGY P10 F P.170

B0115-0071
KYDEX POUZDRO OWB FROGY P09 NOCTURNE C P.170

B0115-0073
KYDEX POUZDRO OWB FROGY P09 NOCTURNE F P.170



1091-1377-01
CZ P-10 S, C, F 9 × 19
MAGAZINE RELEASE – BLACK

1091-1377-02
RED

1091-1377-03
BLUE

1091-1377-04
GREEN

0580-0323-02
CZ P-10 M MAGAZINE RELEASE
LEFT SIDE

ACCESSORIES PISTOLS

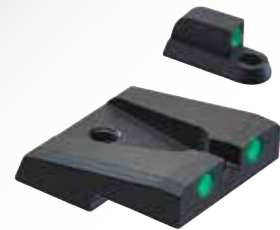

0721-0700-03ND
STEEL TRITIUM SIGHTS H3 (5,50 MM)

0721-0700-02ND
STEEL TRITIUM SIGHTS H2 (5,50 MM)

0721-0700-04ND
STEEL TRITIUM SIGHTS H4 (6,00 MM)



1081-0101
CZ SHADOW 2
ADJUSTABLE REAR SIGHT



B0106-0017-07
CZ TS ORANGE
ADJUSTABLE REAR SIGHT



1081-0220
CZ TS 2
FULLY ADJUSTABLE REAR SIGHT



1091-1250-01
FRONT SIGHT WITH DOT H1 5,25 MM

1091-1250-02
FRONT SIGHT WITH DOT H2 5,50 MM

1091-1250-03
FRONT SIGHT WITH DOT H3 5,75 MM

1091-1250-04
FRONT SIGHT WITH DOT H4 6,00 MM

1091-1250-05
FRONT SIGHT WITH DOT H5 6,25 MM

1091-1250-06
FRONT SIGHT WITH DOT H6 6,50 MM

1091-1250-07
FRONT SIGHT WITH DOT H7 6,75 MM

1091-1250-08
FRONT SIGHT WITH DOT H8 7,00 MM

1091-1250-09
FRONT SIGHT WITH DOT H9 7,50 MM

1091-1250-10
FRONT SIGHT WITH DOT H10 8,00 MM

1091-1250-11
FRONT SIGHT WITH DOT H11 8,50 MM



1091-1251-01
CHECKERED FRONT SIGHT H1 5,25 MM

1091-1251-02
CHECKERED FRONT SIGHT H2 5,50 MM

1091-1251-03
CHECKERED FRONT SIGHT H3 5,75 MM

1091-1251-04
CHECKERED FRONT SIGHT H4 6,00 MM

1091-1251-05
CHECKERED FRONT SIGHT H5 6,25 MM

1091-1251-06
CHECKERED FRONT SIGHT H6 6,50 MM

1091-1251-07
CHECKERED FRONT SIGHT H7 6,75 MM (UNI ADAPT.)

1091-1251-08
CHECKERED FRONT SIGHT H8 7,00 MM

1091-1251-09
CHECKERED FRONT SIGHT H9 7,50 MM

1091-1251-10
CHECKERED FRONT SIGHT H10 8,00 MM

1091-1251-11
CHECKERED FRONT SIGHT H11 8,50 MM



1091-1252-01
FIBER OPTIC FRONT SIGHT H1 1x5,25 MM

1091-1252-02
FIBER OPTIC FRONT SIGHT H2 1x5,50 MM

1091-1252-03
FIBER OPTIC FRONT SIGHT H3 1x5,75 MM

1091-1252-04
FIBER OPTIC FRONT SIGHT H4 1x6,00 MM

1091-1252-05
FIBER OPTIC FRONT SIGHT H5 1x6,25 MM

1091-1252-06
FIBER OPTIC FRONT SIGHT H6 1x6,50 MM

1091-1252-07
FIBER OPTIC FRONT SIGHT H7 1x6,75 MM

1091-1252-08
FIBER OPTIC FRONT SIGHT H8 1x7,00 MM

1091-1252-09
FIBER OPTIC FRONT SIGHT H9 1x7,50 MM

1091-1252-10
FIBER OPTIC FRONT SIGHT H10 1x8,00 MM

1091-1252-11
FIBER OPTIC FRONT SIGHT H11 1x8,50 MM



1091-1253-01
FIBER OPTIC FRONT SIGHT H1 1,5x5,25 MM

1091-1253-02
FIBER OPTIC FRONT SIGHT H2 1,5x5,50 MM

1091-1253-03
FIBER OPTIC FRONT SIGHT H3 1,5x5,75 MM

1091-1253-04
FIBER OPTIC FRONT SIGHT H4 1,5x6,00 MM

1091-1253-05
FIBER OPTIC FRONT SIGHT H5 1,5x6,25 MM

1091-1253-06
FIBER OPTIC FRONT SIGHT H6 1,5x6,50 MM

1091-1253-07
FIBER OPTIC FRONT SIGHT H7 1,5x6,75 MM

1091-1253-08
FIBER OPTIC FRONT SIGHT H8 1,5x7,00 MM

1091-1253-09
FIBER OPTIC FRONT SIGHT H9 1,5x7,50 MM

1091-1253-10
FIBER OPTIC FRONT SIGHT H10 1,5x8,00 MM

1091-1253-11
FIBER OPTIC FRONT SIGHT H11 1,5x8,50 MM

FRONT SIGHT HEIGHT	FRONT SIGHT WITH DOT *	FRONT SIGHT WITHOUT DOT *	FIBER OPTIC FRONT SIGHT 1 MM **	FIBER OPTIC FRONT SIGHT 1.5 MM **
5,25 mm	1091-1250-01	1091-1251-01	1091-1252-01	1091-1253-01
5,5 mm	1091-1250-02	1091-1251-02	1091-1252-02	1091-1253-02
5,75 mm	1091-1250-03	1091-1251-03	1091-1252-03	1091-1253-03
6 mm	1091-1250-04	1091-1251-04	1091-1252-04	1091-1253-04
6,25 mm	1091-1250-05	1091-1251-05	1091-1252-05	1091-1253-05
6,5 mm	1091-1250-06	1091-1251-06	1091-1252-06	1091-1253-06
6,75 mm	1091-1250-07	1091-1251-07	1091-1252-07	1091-1253-07
7 mm	1091-1250-08	1091-1251-08	1091-1252-08	1091-1253-08
7,5 mm	1091-1250-09	1091-1251-09	1091-1252-09	1091-1253-09
8 mm	1091-1250-10	1091-1251-10	1091-1252-10	1091-1253-10
8,5 mm	1091-1250-11	1091-1251-11	1091-1252-11	1091-1253-11

* CZ P-07, CZ P-09, CZ 75 COMPACT, CZ 75 D COMPACT, CZ 75, CZ 75 B Ω, CZ 85, CZ 97, CZ SP-01, CZ 75 SP-01 TACTICAL, CZ SHADOW, CZ 75 SP-01 PHANTOM, CZ 75 TS, CZ 75 TS CZECHMATE,

** CZ 75 COMPACT, CZ 75 D COMPACT, CZ 75, CZ 75 B Ω, CZ 85, CZ 97, CZ SP-01, CZ 75 SP-01 TACTICAL, CZ SHADOW, CZ 75 SP-01 PHANTOM, CZ 75 TS, CZ 75 TS CZECHMATE

	REAR SIGHT HEIGHT	DEFENDER REAR SIGHT WITH DOT	DEFENDER REAR SIGHT WITHOUT DOT	TARGET REAR SIGHT WITH DOT	TARGET REAR SIGHT WITHOUT DOT	FIBER OPTIC REAR SIGHT
CZ P-07 / CZ P-09	7,3 mm	1091-1260	1091-1263	1091-1266	1091-1269	1091-1272
CZ 75 / CZ 85 / CZ SP-01	8,3 mm	1091-1261	1091-1264	1091-1267	1091-1270	1091-1273
CZ 75 SP-01 SHADOW	10 mm	1091-1262	1091-1265	1091-1268	1091-1271	1091-1274

	SIGHT HEIGHT	WITH 1 MM FIBER OPTIC	WITH 1,5 MM FIBER OPTIC	TRITIUM FRONT SIGHT	TRITIUM REAR SIGHT
CZ P-07 / CZ P-09	5,5 mm	1091-1282-02	1091-1283-02	0720-0600-06ND	0720-0690-01ND
CZ P-07 / CZ P-09	5,75 mm	1091-1282-03	1091-1283-03	0720-0600-07ND	0720-0690-01ND
CZ P-07 / CZ P-09	6 mm	1091-1282-04	1091-1283-04	0720-0600-08ND	0720-0690-01ND



B0101-0004
RED DOT HOLOSUN HE508T-RD X2
B0101-0012
RED DOT HOLOSUN HE509T-RD X2
B0101-0006
RED DOT HOLOSUN HS407K X2



3700-7801
TRIJICON SRO – RED DOT SIGHT, 1 MOA
3700-7800
TRIJICON SRO – RED DOT SIGHT, 2,5 MOA
3700-7802
TRIJICON SRO – RED DOT SIGHT, 5 MOA



B0101-0013
RED-DOT SHIELD RMS2-4MOA-GLASS
B0101-0014
RED DOT SHIELD SMS2-4MOA-GLASS



3700-7700
TRIJICON RMR – RED DOT SIGHT



B0103-0001
STREAMLIGHT TLR-7 FLASHLIGHT A SML69424
B0103-0002
STREAMLIGHT TLR-8 FLASHLIGHT A (RED LASER)
B0103-0003
STREAMLIGHT TLR-8 G FLASHLIGHT (GREEN LASER)
B0103-0004
STREAMLIGHT TLR-1 HL FLASHLIGHT SML69260
B0103-0005
STREAMLIGHT TLR-1 FLASHLIGHT S SML69210
B0103-0006
STREAMLIGHT TLR-9 FLEX FLASHLIGHT SML69464



B0101-0001
AIMPOINT ACRO C-2 – RED DOT SIGHT



1070-7010
SPUHR 2-PIECE MOUNT,
1" DIAMETER, 1" HEIGHT

1070-7011
SPUHR 2-PIECE MOUNT,
30 MM DIAMETER, 1" HEIGHT

1070-7012
SPUHR 2-PIECE MOUNT,
34 MM DIAMETER, 1,18" HEIGHT



1070-7013
SPUHR ISMS 2-PIECE MOUNT,
30 MM DIAMETER, 1" HEIGHT

1070-7014
SPUHR ISMS 2-PIECE MOUNT,
34 MM DIAMETER, 1" HEIGHT



C0300-0017
CZ 600 WEAVER RAIL FOR DURALUMIN RECEIVER – MEDIUM

C0300-0018
CZ 600 WEAVER RAIL FOR DURALUMIN RECEIVER – LONG



C0300-0003
CZ 600 LONG PICATINNY RAIL, 0 MOA

C0300-0001
CZ 600 MEDIUM PICATINNY RAIL, 0 MOA

C0300-0002
CZ 600 MEDIUM PICATINNY RAIL, 25 MOA

C0300-0000
CZ 600 SHORT PICATINNY RAIL, 0 MOA



C0300-0004
CZ 600 2-PIECE REMINGTON MOUNT,
1" DIAMETER, 30 MM HEIGHT

C0300-0005
2-PIECE MOUNT, 30 MM DIAMETER,
34 MM HEIGHT

C0300-0006
2-PIECE MOUNT, 34 MM DIAMETER,
34 MM HEIGHT



C0300-0007
CZ 600 2-PIECE WEAVER MOUNT,
1" DIAMETER, 30 MM HEIGHT

C0300-0008
2-PIECE MOUNT, 30 MM DIAMETER, 34 MM HEIGHT

C0300-0009
2-PIECE MOUNT, 34 MM DIAMETER, 34 MM HEIGHT



C0300-0010
CZ 600 MINI ONE-PIECE WEAVER MOUNT,
30 MM DIAMETER, 30 MM HEIGHT

C0300-0011
MEDIUM 30 MM DIAMETER, 34 MM HEIGHT

C0300-0012
MEDIUM 34 MM DIAMETER, 34 MM HEIGHT

C0300-0013
LONG 30 MM DIAMETER, 34 MM HEIGHT

C0300-0014
LONG 34 MM DIAMETER, 34 MM HEIGHT



C0300-0015
CZ 600 ONE-PIECE MEDIUM REMINGTON
MOUNT, 30 MM DIAMETER, 34 MM HEIGHT

C0300-0016
MEDIUM 34 MM DIAMETER, 34 MM HEIGHT

1070-7016
SPUHR RED DOT SIGHT ADAPTER –
TRIJICON RMR MOUNT

1070-7015
SPUHR RED DOT SIGHT ADAPTER –
DELTA POINT MOUNT



**ACCESSORIES
CENTERFIRE RIFLES**



C0302-0000
MEOPTA MEOSPORT R 3-15 x 50 RD SFP RIFLESCOPE



C0302-0001
LEICA MAGNUS 1-6.3 x 24 I (L-3D) RIFLESCOPE



C0302-0002
LEICA FORTIS 6 2.5-15 02 x 56 I (L-4A) RIFLESCOPE



C0302-0006
RIFLESCOPE TRACE ADVANCED 5-30X56ED RMG 2 ILLUMINATED TR5306F-IR



C0307-0016M
SILENCER A-TEC OPTIMA 45 ≤ 223 15x1
C0307-0025M – 45 ≤ 6,5 15x1
C0307-0019M – 45 ≤ 30 15x1
C0307-0021M – 45 ≤ 338 15x1
C0307-0031M – 45 ≤ 6,5 18x1
C0307-0032M – 45 ≤ 30 18x1



C0307-0017M
SILENCER A-TEC OPTIMA 50 ≤ 223 15x1
C0307-0026M – 50 ≤ 6,5 15x1
C0307-0027M – 50 ≤ 30 15x1
C0307-0022M – 50 ≤ 338 15x1
C0307-0033M – 50 ≤ 6,5 18x1
C0307-0034M – 50 ≤ 30 18x1



C0108-0000
BIPOD TACTICAL TK4 6,5-9" CZ 600 MDT



6000-7202-01ND
CZ 600 TRIGGER GUARD FOR WOOD STOCK



A0310-0028
LONG CLEANING ROD – CARBON FIBER Ø 5 L=910MM UNC 8-32



C0310-0000
223 REM. CLEANING BRUSH SET



6000-0010-01ND
M15 x 1 THREAD PROTECTOR, LIGHT PROFILE BARREL

6000-0010-04ND
M15 x 1 THREAD PROTECTOR, SEMI-HEAVY PROFILE BARREL

6000-0010-08ND
M18 x 1 THREAD PROTECTOR, HEAVY PROFILE BARREL



6000-3322-01ND
CZ 600 PLASTIC BOLT KNOB



6000-3320-02ND
CZ 600 WOOD BOLT KNOB



6000-3320-03ND
CZ 600 RANGE DURALUMIN BOLT KNOB



6000-3320-51ND
CZ 600 TRAIL DURALUMIN BOLT KNOB



6002-9000-01ND
CZ 600 CENTERFIRE RIFLE TOOLS



6003-4000-6401ND
CZ 600 MAG 308 WIN., 5 ROUND

6003-4000-7301ND
CZ 600 MAG 7,62 x 39, 5 ROUND



6003-4000-5301ND
CZ 600 MAG 308 WIN., 6 MM CREEDMOOR, 6,5 CREEDMOOR - 5 ROUND / 6,5 PRC - 3 ROUND

6003-4500-5301ND
CZ 600 MAG 308 WIN., 6 MM CREEDMOOR, 6,5 CREEDMOOR, 243 WIN. - 10 ROUND / 6,5 PRC - 6 ROUND



6003-4000-6901ND
CZ 600 MAG 30-06 SPRING., 8 x 57 IS - 5 ROUND / 300 WIN. MAG. - 3 ROUND



6003-4500-5301ND
CZ 600 MAG 308 WIN., 6 MM CREEDMOOR, 6,5 CREEDMOOR, 243 WIN. - 10 ROUND / 6,5 PRC - 6 ROUND

**ACCESSORIES
CENTERFIRE RIFLES**



5120-0600
CZ PREMIUM RIFLE BAG – BROWN



5120-0700
CZ PREMIUM RIFLE BAG – GREEN



5500-2990-01ND
TRIGATTI SLING STUD FOR SLING
LOOP ON WOOD STOCK



545130060481
MUZZLE BRAKE FOR M18 x 1 THREAD,
ONLY FOR CZ TSR



1081-7383
TRIGATTI SLING LOOP
(2 PCS IN PACKAGE)



1002-4100-05
ATI SLING LOOP ON RIFLE SLING



5812-1293-04ND
CZ 457 / CZ 600 SLING LOOP
FOR WOOD STOCKS



C0315-0000
CZ GAMEHAMMER RIFLE SLING – BLACK
C0315-0001
CZ GAMEHAMMER RIFLE SLING – GREEN
C0315-0002
CZ SAUENHAMMER RIFLE SLING – ORANGE



5120-0110-01
CZ RIFLE SLING, NYLON / RUBBER – GREEN



5120-0110-02
CZ RIFLE SLING, NYLON / RUBBER – BROWN



5120-0110-03
CZ RIFLE SLING, NYLON / RUBBER – ORANGE



5120-0110-04
CZ RIFLE SLING, TWEED / RUBBER – TWEED



5120-0110-11
CZ RIFLE SLING, LEATHER / RUBBER – LIGHT BROWN



5120-0110-12
CZ RIFLE SLING, LEATHER / RUBBER – DARK BROWN



5120-0110-09
CZ RIFLE SLING, NYLON / RUBBER – BLACK



5120-0110-05
CZ RIFLE SLING, NYLON / RUBBER – CAMOUFLAGE

**ACCESSORIES
RIMFIRE RIFLES**



5133-1000-01ND
CZ 455 / CZ 457 / CZ 512
22 LR METAL MAGAZINE, 5 ROUND



5073-1000-8802ND
CZ 455 / CZ 457 / CZ 512
22 WMR / 17 HMR DURABLE
POLYMER MAGAZINE, 5 ROUND



5133-1000-02ND
CZ 455 / CZ 457 / CZ 512
22 LR DURABLE POLYMER
MAGAZINE, 5 ROUND



5133-1200-02ND
CZ 455 / CZ 457 / CZ 512
22 LR DURABLE POLYMER
MAGAZINE, 10 ROUND



5073-1200-8802ND
CZ 455 / CZ 457 / CZ 512
22 WMR / 17 HMR DURABLE
POLYMER MAGAZINE, 10 ROUND



5133-1200-01ND
CZ 455 / CZ 457
22 LR METAL MAGAZINE, 10 ROUND



5131-1001-02ND
ONE ROUND MAGAZINE



5123-1225-03ND
CZ 455 / CZ 457 / CZ 512
22 LR DURABLE POLYMER
MAGAZINE, 15 ROUND



5123-1225-02ND
CZ 455 / CZ 457 / CZ 512
22 LR DURABLE POLYMER
MAGAZINE, 25 ROUND



1070-7001
CZ 455 / CZ 457 / CZ 512
2-PIECE MOUNT, 1" DIAMETER



1070-7016
SPUHR PLATE FOR MOUNTING
TRIJICON RMR RED DOT SIGHTS

1070-7015
SPUHR PLATE FOR MOUNTING
DELTA POINT RED DOT SIGHTS



1070-7002
CZ 455 / CZ 457 / CZ 512
2-PIECE MOUNT, 30 MM DIAMETER



5083-9059-01ND
CZ 457 DIOPTR ADAPTER RAIL



1070-9057
CZ 457 PICATINNY RAIL, BLACK

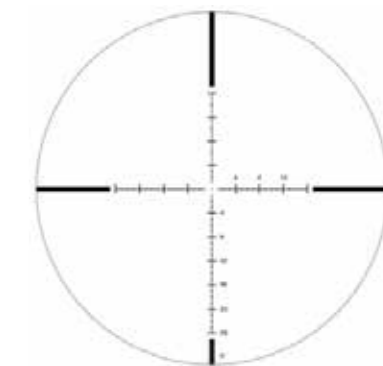

C0302-0005
RIFLESCOPE 3-12x40 VENGEANCE R3 SFP

The VENGEANCE range of riflescopes delivers a quality, value for money shooting experience without short-changing on feature availability and robust engineering.

Lens Diameter:	40 mm
Magnification:	3-12x
Tube Diameter:	1"
Reticle Focal Plane:	Reticle R3 SFP
Illumination Type:	No
Adjustment Click Value:	¼ MOA
Parallax:	50 m
Resistance to Weather Conditions:	Yes
Waterproof:	Yes



1070-9058
CZ 457 PICATINNY RAIL, 25 MOA, BLACK

**ACCESSORIES
RIMFIRE RIFLES**



5083-0096-8591V1ND
CZ LRP 22 LR MINISET, 5 ROUND, 525 MM, 1/2 x 20



5083-0190-83V1ND
CZ 457 JAGUAR 22 LR MINISET, 10 ROUND, 726 MM, 1/2 x 20

5083-0190-8982V1ND
CZ 457 PREMIUM 17 HMR MINISET, 24" 1/2 x 20

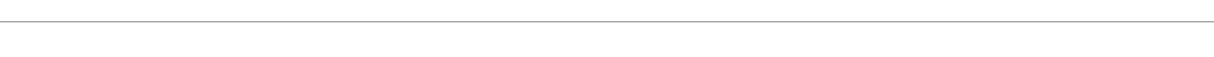

5083-0190-82V1ND
CZ 457 PREMIUM 22 LR MINISET, 24" 1/2 x 20

083-0190-8882V1ND
CZ 457 PREMIUM 22 WMR MINISET, 24" 1/2 x 20



5083-0090-8991V1ND
CZ 457 VARMINT 17 HMR MINISET, 5 ROUND, 525 MM, 1/2 x 20

5083-0090-8594V1ND
CZ 457 VARMINT MTR 22 LR MATCH MINISET, 16" 1/2 x 20



5083-0090-8591V1ND
CZ 457 VARMINT MTR 22 LR MATCH MINISET, 20" 1/2 x 20

5083-0090-91V1ND
CZ 457 VARMINT 22 LR MINISET, 20" 1/2 x 20



5083-0090-8891V1ND
CZ 457 VARMINT 22 WMR MINISET, 20" 1/2 x 20



5083-0090-8594V1ND
CZ 457 MTR 22 LR MINISET, 5 ROUND, 525 MM, 1/2 x 20



5083-0190-8982V1ND
CZ 457 AMERICAN 17 HMR MINISET, 5 ROUND, 630 MM, 1/2 x 20



5083-0090-8982V1ND
CZ 457 AMERICAN 17 HMR MINISET, 24" 1/2 x 20



5083-0090-82V1ND
CZ 457 AMERICAN 22 LR MINISET, 24" 1/2 x 20



5083-0090-8882V1ND
CZ 457 AMERICAN 22 WMR MINISET, 24" 1/2 x 20



5083-0091-81V1ND
CZ 457 STAINLESS 22 LR MINISET, 5 ROUND, 525 MM, 1/2 x 20



5120-0330-01
CZ 457 RUBBER BOLT KNOB



5070-0070-11ND
COMPENSATOR FOR 1/2 x 20 UNF THREAD (AMERICAN)

5070-0070-21ND
COMPENSATOR FOR 1/2 x 20 UNF THREAD (VARMINT)



5080-0060-80ND
1/2 x 20 UNF THREAD PROTECTOR (AMERICAN)

5080-0060-90ND
1/2 x 20 UNF THREAD PROTECTOR (VARMINT)



C0307-0010
SILENCER A-TEC CMM-6 22LR 1/2"-20



C0307-0012
SILENCER WAVE 22LR 1/2"-20

C0307-0011
SILENCER A-TEC CMM-6 22LR 1/2"-28

C0307-0013
SILENCER WAVE 22LR 1/2"-28

C0307-0014
SILENCER WAVE CARBON 22LR 1/2"-20

C0307-0015
SILENCER WAVE CARBON 22LR 1/2"-28



A0310-0028
LONG CLEANING ROD - CARBON FIBER Ø 5 L=910MM UNC 8-32



C0405-0000
CZ 457 TRIGGER GUARD - BLACK

C0405-0001
CZ 457 TRIGGER GUARD - GOLD

C0405-0002
CZ 457 TRIGGER GUARD - GREEN

C0405-0003
CZ 457 TRIGGER GUARD - RED

C0405-0004
CZ 457 TRIGGER GUARD - BLUE



C0310-0000
223 REM. CLEANING BRUSH SET



5120-0400
CZ BASIC RIFLE BAG - BLACK



5120-0500
CZ BASIC RIFLE BAG - FDE

**ACCESSORIES
SEMI-AUTO**



A0203-0013
TACT. FLASHLIGHT WML 450 LM IF71011
A0203-0014
TACT. FLASHLIGHT WML 450LM IF71011DE FDE
A0203-0015
TACT. FLASHLIGHT WML 400 LM IR IF71013
A0203-0016
TACT. FLASHLIGHT WMLX 1100LM IF71012
A0203-0017
TACT. FLASHLIG. WMLX 900LM IR IF71014



A0203-0009
SUREFIRE M600DF-BK FLASHLIGHT

A0203-0010
SUREFIRE M312C-BK FLASHLIGHT

A0203-0012
SUREFIRE M340 DFT PRO TURBO FLASHLIGHT

A0103-0018
SUREFIRE 1000LM M640U-BK-PRO FLASHLIGHT



A0101-0027
AIMPOINT MICRO H-2 LRP
RED DOT SIGHT MOUNT 39 MM 200211



A0212-0003
CZ BREN 2, CZ SCORPION EVO 3
SET - STANDARD FPS DURAL SIGHTS

A0212-0004
CZ BREN 2, CZ SCORPION EVO 3
SET - STANDARD FPS SAFETY SIGHTS

A0212-0005
CZ BREN 2, CZ SCORPION EVO 3
SET - STANDARD FPS PLAST SIGHTS



A0210-0014
AIM 50 TACTICAL DRAGBAG - GREEN

A0210-0013
AIM 40 TACTICAL DRAGBAG - GREEN



3722-3500-7310ND
CZ MAG 7,62 x 39, 10 ROUND



3722-3500-6501 ND
CZ MAG 5,56 x 45, 30 ROUND

3722-3500-6503ND
CZ MAG 5,56 x 45, 10 ROUND



A0106-0002
CZ SCORPION EVO 3 MAG 22 LR,
10 ROUND



3662-0770-0725ND
CZ SCORPION EVO 3 MAG 9 x 19, 20 ROUND

3662-0800-0715ND
CZ SCORPION EVO 3 MAG 9 x 19, 10 ROUND

3662-0780-0735 ND
CZ SCORPION EVO 3 MAG 9 x 19, 30 ROUND



A0101-0010
TRIJICON MRO RED DOT SIGHT, 39 MM, SCREW



A0201-0020
RED DOT HOLOSUN HS403B



A0201-0026
MAGNIFIER MODUL HOLOSUN HM3X



A0210-0007
SM-2001 MICRO MOUNT

A0210-0010
SM-3002 MOUNT FOR TRIJICON MRO RED DOT SIGHT,
ABSOLUTE



A0210-0012
QDM-3001 MOUNT FOR TRIJICON MRO RED DOT SIGHT



A0210-0002
QD SLING SWIVEL 47 MM

A0310-0003
QD SLING SWIVEL 25 MM



A0310-0006
M-LOK QD MOUNT FOR SLING LOOP



D2800-0300
1/2 POINT SLING FOR CZ BREN 2 - BLACK

D2800-0600
1/2 POINT SLING FOR CZ BREN 2 - FDE



A0107-0010M
SILENCER A-TEC SMG 9MM SCORPION 1/2"-28

A0107-0011M
SILENCER A-TEC SMG 9MM SCORPION M18x1

A0107-0012M
SILENCER A-TEC SMG 9MM SCORPION SHORT M18x1



A0207-0068M
SILENCER A-FLOW SHORT 223 REM. QD-LOCK BIRDCAGE 1/2-28

A0207-0070M
SILENCER A-FLOW NORMAL 223 REM. QD-LOCK BIRDCAGE 1/2-28



A0105-0001
CZ SCORPION EVO 3 FRONT HAND GUARD



A0105-0002
FRONT HAND GUARD FOR
CZ SCORPION EVO 3, M-LOK



A0310-0007
M-LOK DURAL RAIL, 5 SLOTS

A0310-0008
M-LOK DURAL RAIL, 3 SLOTS

A0310-0019
M-LOK DURAL RAIL, 9 SLOTS

A0310-0020
M-LOK DURAL RAIL, 11 SLOTS



A0308-0007
BIPOD TACTICAL TK4 6,5-9" COMBAT



A0308-0008
BIPOD TACTICAL TK4 6,5-9" PRS WEAVER

LIMITED EDITIONS

CZ is proud of the tradition and exceptional quality it has been bringing to market for decades. For important anniversaries, events, or milestones, we create limited editions of our firearms that merge precise, modern technology with the masterful craftsmanship of our engravers.



MORE INFO HERE:
<https://www.czub.cz/en/limited-editions/>



Each piece is a unique work of art that bears the stamp of impeccable design, functionality, and the love of detail. These unique firearms are not only a testament to the CZ tradition, but also a symbol that represents the union of history and innovation.

For true collectors and connoisseurs of exceptional firearms, we offer the opportunity

to acquire these limited editions through auctions. This opportunity is not only the chance to become the owner of an exclusive masterpiece, but also to support the tradition and art that CZ represents. Our limited editions are more than just firearms - they are a celebration of the seamless blending of technology, craftsmanship, and Czech artistry.



THE COMBINATION OF TRADITION, QUALITY AND ART

CZ CONFIGURATOR

*Build the firearm
of your dreams*

Since 2019, Ceska zbrojovka a.s. has offered its customers an unrivalled opportunity to build a firearm in exact accordance with their wants and needs via an interactive website. You can choose the color of the frame and slide, type of sights (including red dot sights), size and color of the controls, magazine capacity and much more. After placing a binding order, the configured firearm is assembled and ready for final sale, which takes place in accordance with legal regulations.

The CZ Configurator is now available for CZ customers in seven countries around the world – **Czech Republic, Slovakia, France, Germany, Poland, Austria, Italia, Philippines** and the **USA**.

Build the firearm of your dreams now!

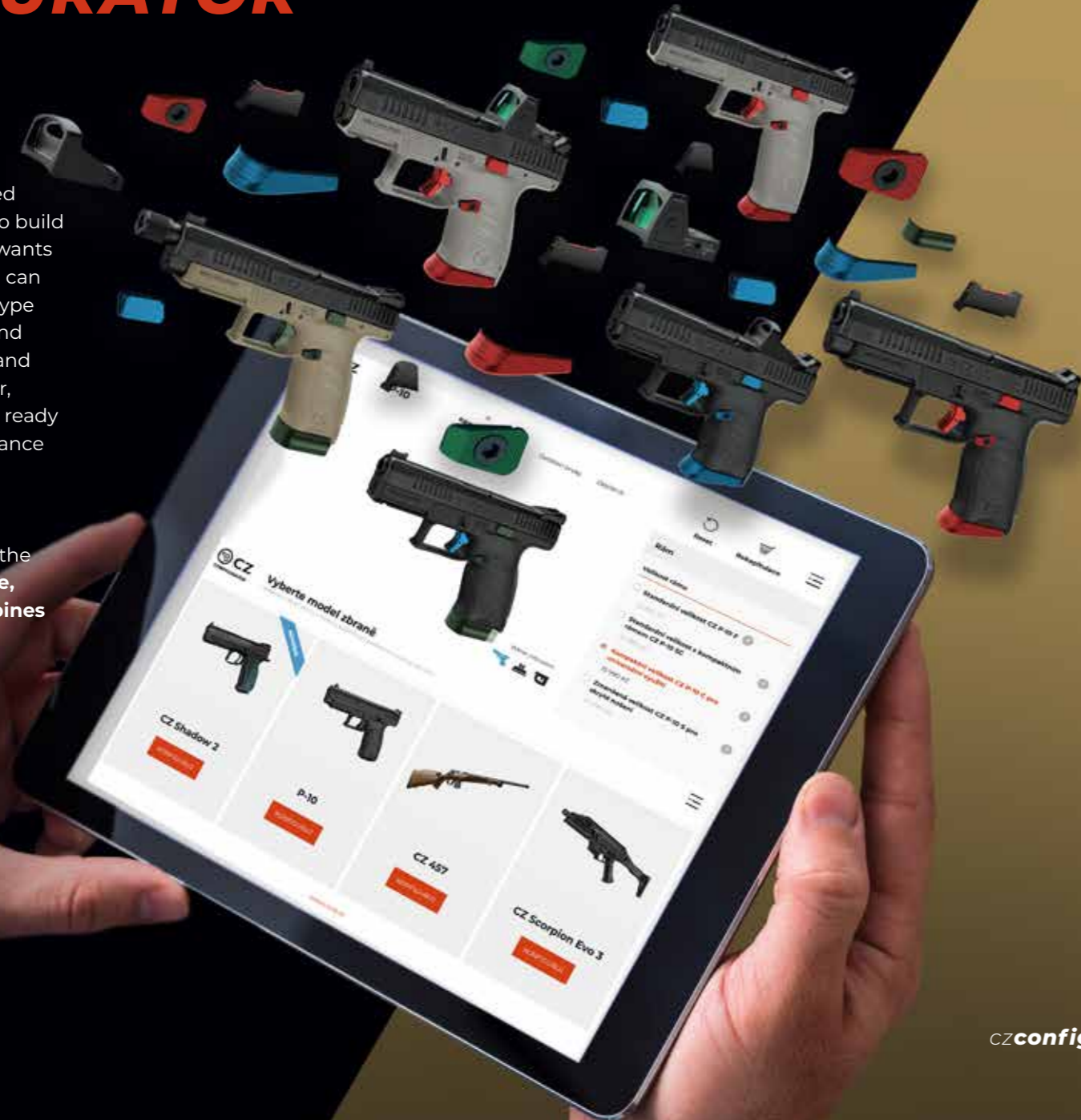

czconfigurator.com

Ceska zbrojovka a.s. is a member of **Colt CZ Group SE**

COLT CZGROUP



